



Evo270-1

Installation & Operation Manual



Contents

1. Introduction	2
2. Quick Start Guide	3
3. Unit Specifications	4
3.1 Dimensions & Technical Data	4
4. Safety Instructions	5
5. Installation	5
5.1 Pipeline Connection	5
5.2 Handling & Transportation	6
5.3 Location of Install & Minimum Clearances	6
5.4 Cable Connection	7
5.5 Filling the Tank	7
5.6 Initial Start-up of the Unit	7
6. Operation	8
6.1 Main Controller Interface	8
6.2 Functions of the Controller	9
6.2.1 Turning the Unit ON & OFF	9
6.2.2 Mode Selection	9
6.2.3 Target Temperature Checking & Setting	10
6.2.4 Hydro Boost Setting	10
6.2.5 Setting the Time and Date	11
6.2.6 Setting the Timer	12
6.2.7 Cancelling the Timer	13
6.2.8 Vacation Mode	13
6.2.9 Keyboard Locking	14
6.2.10 Force Defrosting	14
6.2.11 Fan/Ventilation Function	14
7. Troubleshooting	15
8. Appendix	16
8.1 PCB Description	16
8.2 Caution	17
8.3 Earthing Methodology	17
8.4 Use of the P&T Valve	18
8.5 Using the Overheating Protector	18
8.6 Draining the Water Tank	18
9. Maintenance	19
10. Warranty	20

1. Introduction

This manual contains all the necessary information regarding the installation, troubleshooting, operation and maintenance of this unit. Ensure instructions in this manual are always adhered to. Failing to comply with these recommendations will invalidate the warranty. This manual and all others are available for download on our website.

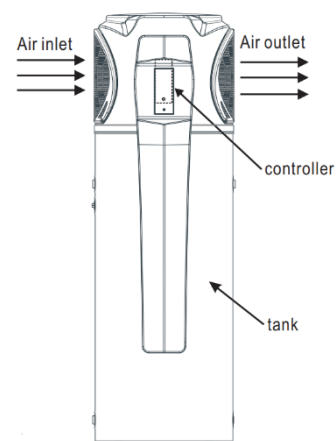

HEATING CAPACITY

In low ambient conditions the heating output decreases.

WORKING CONDITIONS

In order to use the unit correctly, run the unit at environment temperature 0°C → 40°C

The unit contains sophisticated electronic devices, do not use water from a lake, groundwater or other unsafe water sources.

3 MIN SAFETY PROTECT

If the unit stops and you restart the unit or turn it on manually, the unit will not start to run again for approximately 3 minutes. This is a protection feature to safe guard the compressor.

WATER TEMPERATURE OR PRESSURE PROTECTION

A P&T valve **MUST** be installed in the tank. When the tank pressure reaches 0.85MPa or when the tank temperature reaches 99°C, the P&T valve will open automatically so as to reduce the pressure or temperature decrease.

DEFROSTING

In heating mode the unit will defrost automatically, maximising the heating efficiency (lasting 2-10 minutes). The fan motor will stop running whilst the unit is defrosting.

- When installing the Evo 270, follow all instructions as documented in this manual.
- Once the installation is complete, check that all connections are secure before the power is turned on.
- The installer is to explain to the end user how to operate and maintain the unit in accordance with this instruction manual.
- Evo Industries Australia Pty Ltd will not be held responsible for any damages or injuries caused by the incorrect installation of this hot water system.
- A maintenance programme must be carried out as recommended in this manual to ensure ongoing reliability.
- Failure to comply with these recommendations could void the warranty and cause injury or death.
- Due to continuous product improvement, this manual may be subject to change without prior notice.

Recommended Household Size













The below recommendations are based on heat pump only mode. Higher occupancy levels can be achieved with the Hydroboost heater function activated.

Household Size	Model
Up to 6 People	Evo270-1

Notice: High usage of hot water and other factors could affect this recommendation. Please consult your supplier if you have special requirements.

QUICK START GUIDE

INITIAL SET UP

1. Press and hold  for one second to power on the unit.
2. To set the time:
 - a. Press  once so the hour digit starts flashing,
 - b. Use   to adjust the hour and press  to confirm,
 - c. Repeat for the minute, day, month and year,
 - d. Press  at any stage to cancel.
3. Press  until  is displayed. This will activate “Eco Heating” (Heat Pump only) mode and will provide the most efficient heating.
4. During periods of unusually high hot water demand (such as additional occupants staying with you), you can activate “High Requirement” mode by pressing  until  is displayed.
5. In any event where there is a failure within the system, the Electric Element (Hydroboost Mode) can be engaged with “one push activation” of the  button until  is displayed. This will provide emergency water heating until service can be attended.
6. For adjustment of timers or activating vacation mode, please refer to our online tutorials at:
www.evoheat.com.au/tech-support



Do not drill any fixings or attachments into the outer casing of the tank. Drilling into the outer casing of the tank may damage the heating coil and WILL VOID WARRANTY.

**FOR ADDITIONAL INFORMATION
SEE THE REST OF THIS MANUAL**

3. Unit Specifications

- Refrigerant is compressed into vapor with high temperature and high pressure when it goes through the compressor.
- On the discharge side of the compressor, the now hot and highly pressurized vapor is cooled down through the heat exchange with the water in the tank until it condenses into a high pressure, moderate temperature liquid.
- The pressure of the liquid refrigerant drops as it passes the throttling device.
- Finally, the refrigerant absorbs the heat from the surrounding air and evaporates into vapor with low temperature and low pressure, where it then it goes into the compressor again.

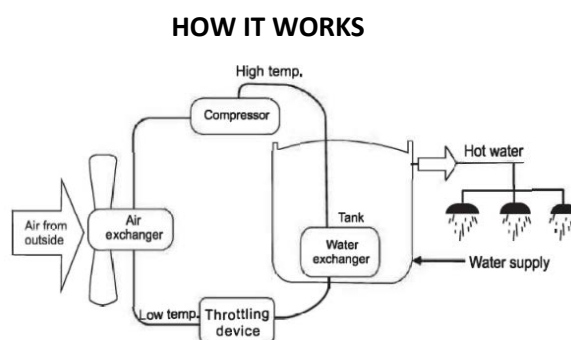

3.1 Dimensions & Technical Data

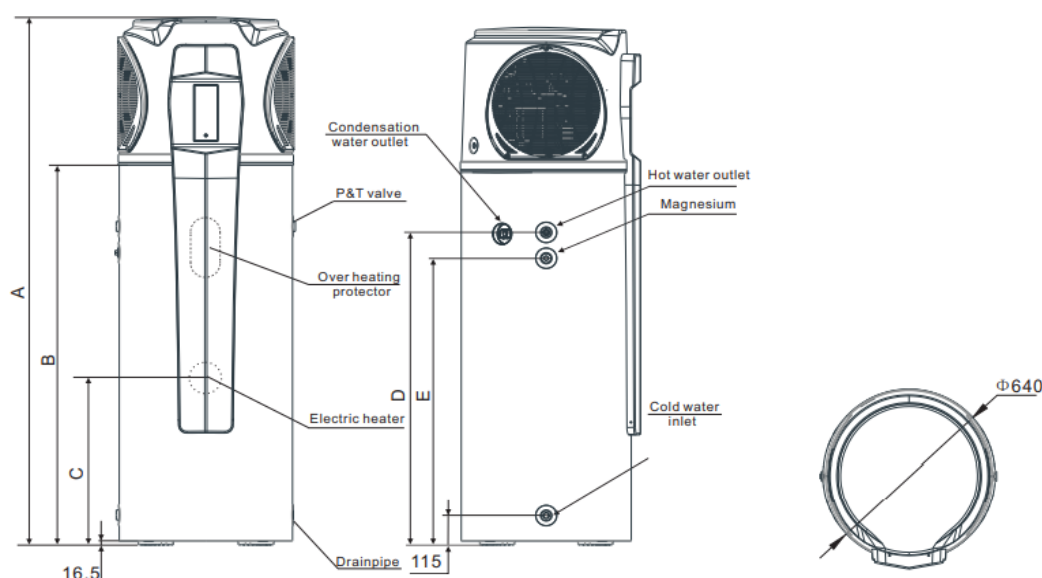

DIMENSIONS (mm)

A	B	C	D	E
1992	1443	593	1211	1111

Model		Evo270-1
Heating capacity	kW	3.6 Heat Pump
Water tank capacity		270
Power input	kW	0.94 Heat Pump
Running current	A	3.90 Heat Pump
Power Supply		220-240V~/50Hz
Compressor Number		1
Compressor		Rotary
Rated outlet water temp.	Deg C	60
Noise	dB(A)	48
Water inlet/outlet size	inch	¾
*Hydroboost power heat	kW	1.5
Net Weight	kg	See name plate
Shipping weight	kg	See package label

Conforms to AS 3498-2009 Australia and New Zealand

Measurement conditions:

Instant heating: Ambient air temperature 20°C/15°C, water inlet 15°C, water outlet 55°C, highest setting temperature: 75°C

Working Temp Range

- 1) Ambient temperature is 0°C to 40°C (Heat Pump)
- 2) The max temperature of water tank is 70

Operating parameters: The range of the operating water pressures: 0.15~0.7MPa

4. Safety Instructions

- A qualified technician is required to install, relocate the unit if required and for all repairs.
- Good earthing is required for both the unit and power connections to prevent electrical shock.
- Ensure that there are no leaks on both the plumbing and drainage fittings.
- The unit must not be installed near flammable gas or have flammable aerosols sprayed in the vicinity.
- The base that the unit is installed on must be level and stable.
- A circuit breaker is required to be installed with this unit.
- Fingers and objects must not be placed into the fan of the unit. Children should be kept clear of the appliance.
- In the event of the unit malfunctioning, shut off the power supply and contact your supplier or EvoHeat.
- Power the unit off during cleaning.
- The unit produces hot water and will also have hot fittings, therefore should not be touched to avoid injury.

5. Installation

5.1 Pipeline Connection

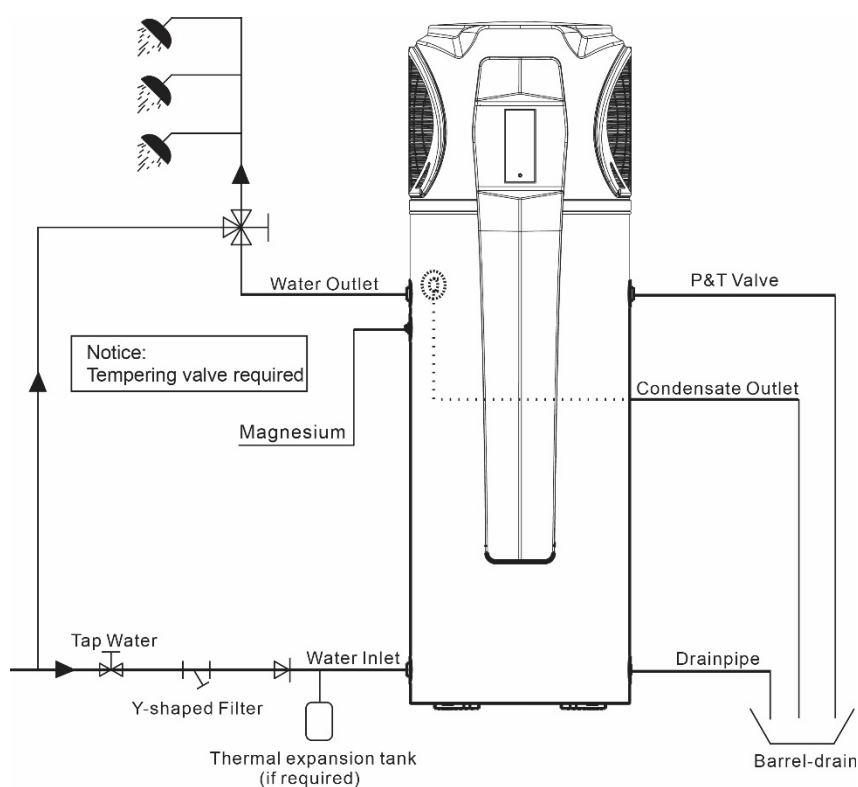

ATTENTION

- Do not drill any fixings or attachments into the outer casing of the tank. Drilling into the outer casing of the tank may damage the heating coil and **WILL VOID WARRANTY.**
- The P&T valve attached with the unit must be installed. Failure to do so will cause damage to the unit and possible personal injury.
- Do not use stainless steel fittings to connect directly with other metals to prevent galvanic corrosion.
- Drain the water tank through the drain valve at the bottom part of the unit.

Note: A pressure releasing valve is to be fitted within the installation.

Spec of P&T valve:
Pressure: 0.85MP
Temperature: 99°C

Installation of the water inlet or outlet pipes: The specification of the water inlet and outlet thread is BSP3/4(internal thread). Pipes must be heat-resistant and durable.

Installation of the pipe for P&T valve: The spec of the valve connecting thread is BSP3/4(internal thread). After installation, it must be confirmed that the drainpipe outlet is exposed in the air. When the flexible drainpipe is joined to the pressure relief orifice of this valve, you must ensure that the flexible drainpipe is pointing downwards and exposed in the air.

5.2 Handling & Transportation

As a rule, the unit should be stored and/or transported in its shipping container in an upright position and without water charge. For transport over short distances, and provided due care is exercised, an inclination angle of up to 30 degrees is permitted. During transport and storage, ambient temperatures of -10 to +60 degrees Celsius are permissible.

Forklift Transportation

When transported by a forklift, the unit must remain mounted on the pallet. The lifting speed should be kept to a minimum. Due to its top heaviness the unit must be secured against tipping over. To prevent any damage or injury, the unit must be placed on a level surface.

Manual Transportation

For manual transport, a wooden pallet can be used to place the unit on. Using ropes or carrying straps, a second or third handling configuration is possible. With this type of handling, care must be taken that the maximum permissible inclination angle of 60 degrees is not exceeded. If transport in an inclined position cannot be avoided, the unit should be left to rest at least one hour after it has been moved into final position before operation.

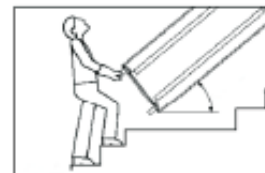

CAUTION: High centre of gravity, place on a level surface!

5.3 Location of Install & Minimum Clearances

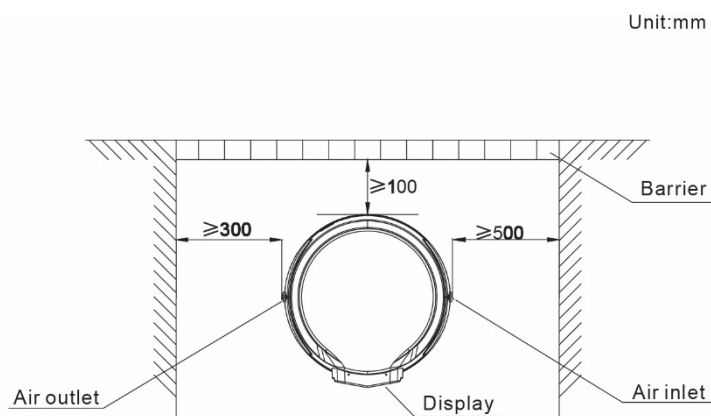
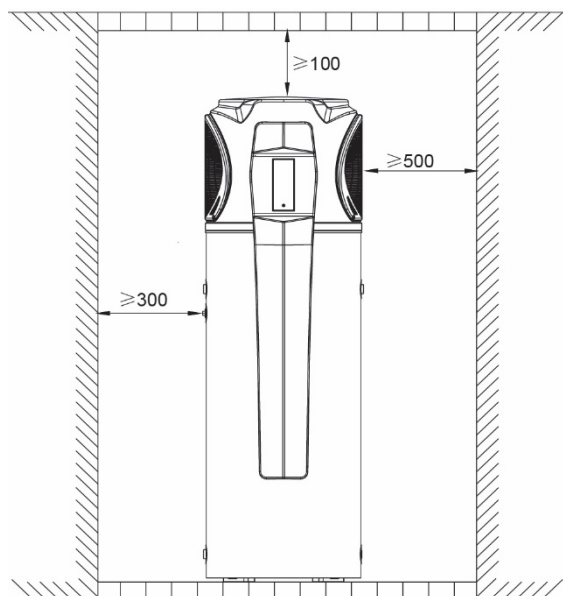

The Evo 270 is designed for external installation; however, if possible, installing the system under the house eaves or in a sheltered environment may help prolong the life of the system.

1. The unit must be installed, operated and maintained in good order and accordance with these instructions.
2. If the water supply exceeds rated pressure a pressure reducing valve is to be fitted.
3. Water may discharge from the drainpipe and this must be left open to the atmosphere.
4. The pressure relief valve must be operated at least every 6 months to ensure correct operation. The drainpipe from this valve should not allow water to collect in pipework.
5. Facilities for draining and filling the unit must be provided to maintenance. Drain points must be at the lowest point of the system.
6. Check before installation that your water pressure is within required limits. Use a filter and pressure relief valve on the inlet as required. A water softening device will also be required in hard water areas.

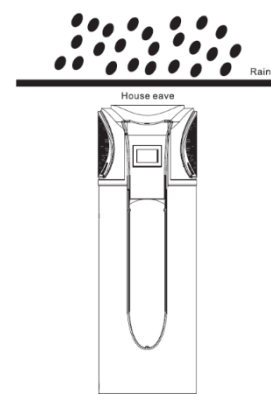

7. This heat pump must be installed by a licensed contractor. Do not attempt to install yourself if you are not qualified. The Evo 270 must be installed to conform to all relevant Australian Standards and Industry Codes including but not limited to:
- Electrical and Electrical Safety
 - Plumbing and Hot Water Storage
 - Heat Pump Installation and Operation

Installation must also comply with any local, state or federal codes at the installation site. Failure to comply can void your warranty, damage your unit or possibly cause injury or death. Plumbing must comply with AS/NZS3500.4

INDOOR INSTALLATION RECOMMENDATIONS

- Heat pumps operate most efficiently with warmer air temperatures, and the outlet air from the unit will always be colder than the inlet air. Therefore, it is advisable to install the unit so it receives the warmest air temperatures possible and that the cold air is not able to recirculate back into the unit.
- The unit may be able to be installed in an unventilated room exceeding 25m³ in volume.
- Venting of cold air is always advisable to prevent the air temperature dropping and lowering the efficiency of the unit.
- Think of the unit as a 3kW air conditioner for the effect it will have on a closed room.

TO COOL THE ROOM USING THE EVO 270

Install the unit so the outlet from the heat pump is blowing INTO the room. The room MUST have some form of air outlet otherwise the performance of the unit will suffer significantly.

TO MAINTAIN THE ROOM AT NORMAL TEMPS USING THE EVO 270

Install the unit so the outlet from the heat pump is blowing OUTSIDE the room. The room MUST have some form of air inlet otherwise the performance of the unit will suffer significantly.

5.4 Cable Connection

The power cable is stored in the back of the unit, it is for the power supply of the unit. The unit requires an isolating switch as required by local laws. If the power cord is damaged, it must be replaced by a qualified electrician.

5.5 Filling the Tank

Open a hot water tap inside the house. Open the cold-water inlet valve into the Evo 270 to fill the tank. When water begins flowing out of the hot water tap inside the premises, turn off the hot water tap.

5.6 Initial Start-up of the Unit

PRE-INSPECTION

Check the water supply to the tank and pipe connections for possible leaks.

Check that the following devices are installed and operating correctly:

- Drainpipes
- P&T Valve
- Filter on inlet
- Water softening and pressure reducing devices if required.

Check that all power connections are secure before switching on.

Check that the installation space is adequate.

TRIAL OPERATION

Switch on the unit by using the controller.

If any unusual noises occur, switch the power off and consult your provider.

The parameters have been pre-set to a temperature of 60 degrees. Check that the unit is operating by looking for an increase in water temperature over time.



6. Operation

Check out EvoHeat’s YouTube channel for videos that walk through the controller usage and different settings. www.youtube.com/evoheat/playlists



6.1 Main Controller Interface

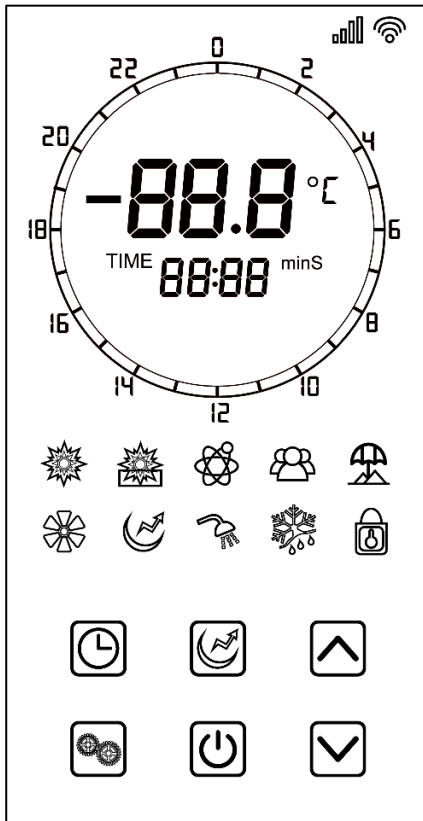

ICON	NAME	FUNCTION
	ON/OFF	Turn the unit on or off.
	UP	Select options to increase values
	DOWN	Select options to decrease values
	CLOCK	Set the clock or the timer.
	HYDROBOOST	Turn on/off the electric heater
	MODE	Switch unit running modes or save setting parameters

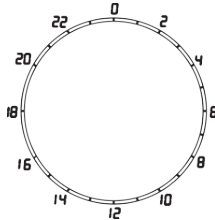



TOUCH TIMING Touch setting timing

Icon	Name	Meaning	Icon	Name	Meaning
	Heating Mode	Enable heating mode		Lock	Keyboard is locked
	Eco Heating Mode	Enable Eco heating mode		DTU	State of DTU connection
	Intelligent Mode	Enable intelligent mode		Wi-Fi	State of Wi-Fi connection *Only available as an optional upgrade
	High Requirement Mode	Enable High requirement mode		Set Temperature Reached	Set temperature has been reached and the unit will shut off automatically
	Vacation Mode	Enable Vacation mode	DOWN	Lower tank temperature	Temperature of the lower tank
	Fan	Fan is on	SET	Parameter setting	Parameter is adjustable
	Hydroboost	The Hydroboost setting is on	min	Minute	Minute value is being set
	Defrost	The unit is defrosting	S	Second	Second value is being set
			TIME	Time	Time is displayed

6.2 Functions of the Controller

6.2.1 Turning the Unit ON & OFF

Press  and hold for 0.5 seconds in the standby screen of the controller to turn the unit on. The main display will now show the water outlet temperature.

Press  and hold for 0.5 seconds in the running screen of the controller to turn the unit off. The main display will now show "OFF".

The unit will dim the screen and display the standby screen when the controller has not been touched for a minute. Touch the power button to wake it.

Note: The ON/OFF button can only be used to turn the unit on/off in standby or on the running screen of the controller.

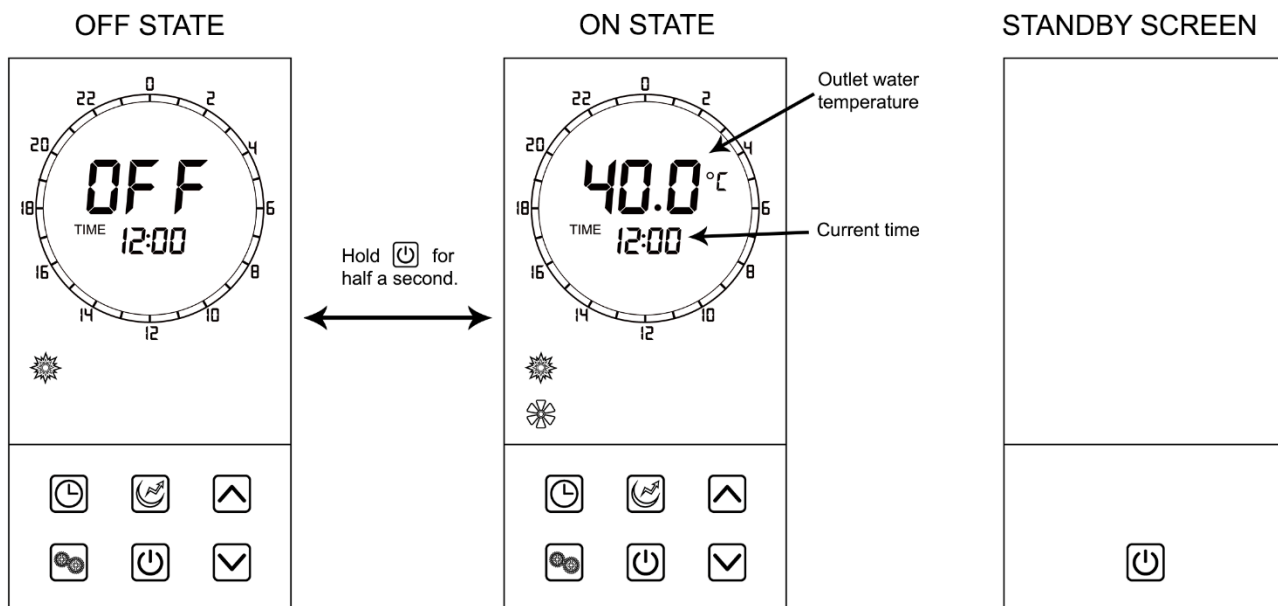

6.2.2 Mode Selection

From the running screen, press  to select one of the modes: Heating, Eco Heating, Intelligent, High requirement, Vacation.

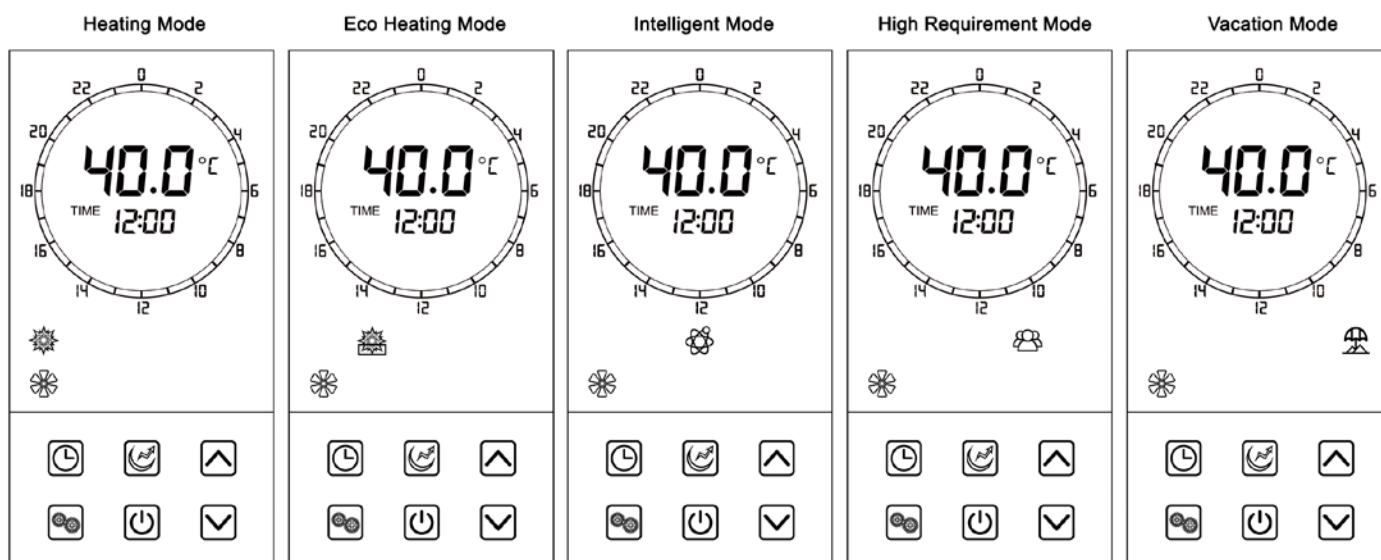

Press  to alternate between different modes.

6.2.3 Target Temperature Checking & Setting

In the standby or running interface, press or once to check the target temperature of the outlet water.

Press or again to change the target temperature.

After making changes to the desired temperature, press to confirm or to cancel, then return to the previous screen.

If the keypad is left idle for 5 seconds, the controller will exit the menu automatically and apply any changes that were made.

Example: The target temperature is 40°C, the actual outlet water temperature is 18°C.

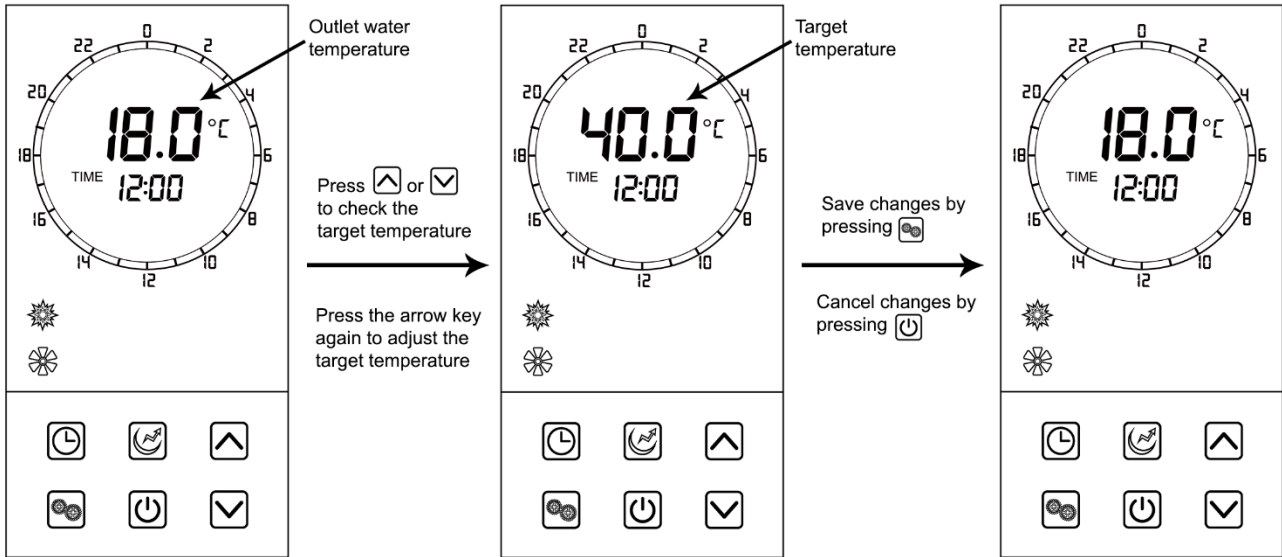

6.2.4 Hydro Boost Setting

The hydro boost setting (also known as Electric Heater) can be turned on when the unit is heating or in standby mode.

Press "" once to turn on hydro boost and press "" again to shut it off.



When the unit is off, press "" to turn on the hydro boost mode. At this time, the "" will light up. The main display area alternate 2S shows "OFF" and outlet water temperature.

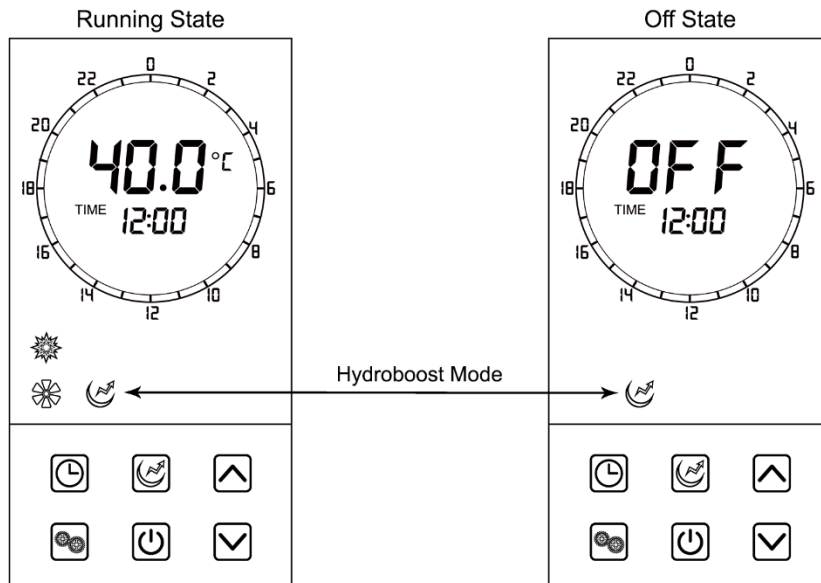

Press "" again to turn off the electric heating mode, the main display will display " OFF "



6.2.5 Setting the Time and Date

In the standby or running interface, press  once, the hour digit will flash.

Press the  or  to change the hour setting, then press  to confirm.

Press the  or  to change the minute setting, then press  to confirm.

During the process, you can press  at anytime and the system will exit the operation without saving.

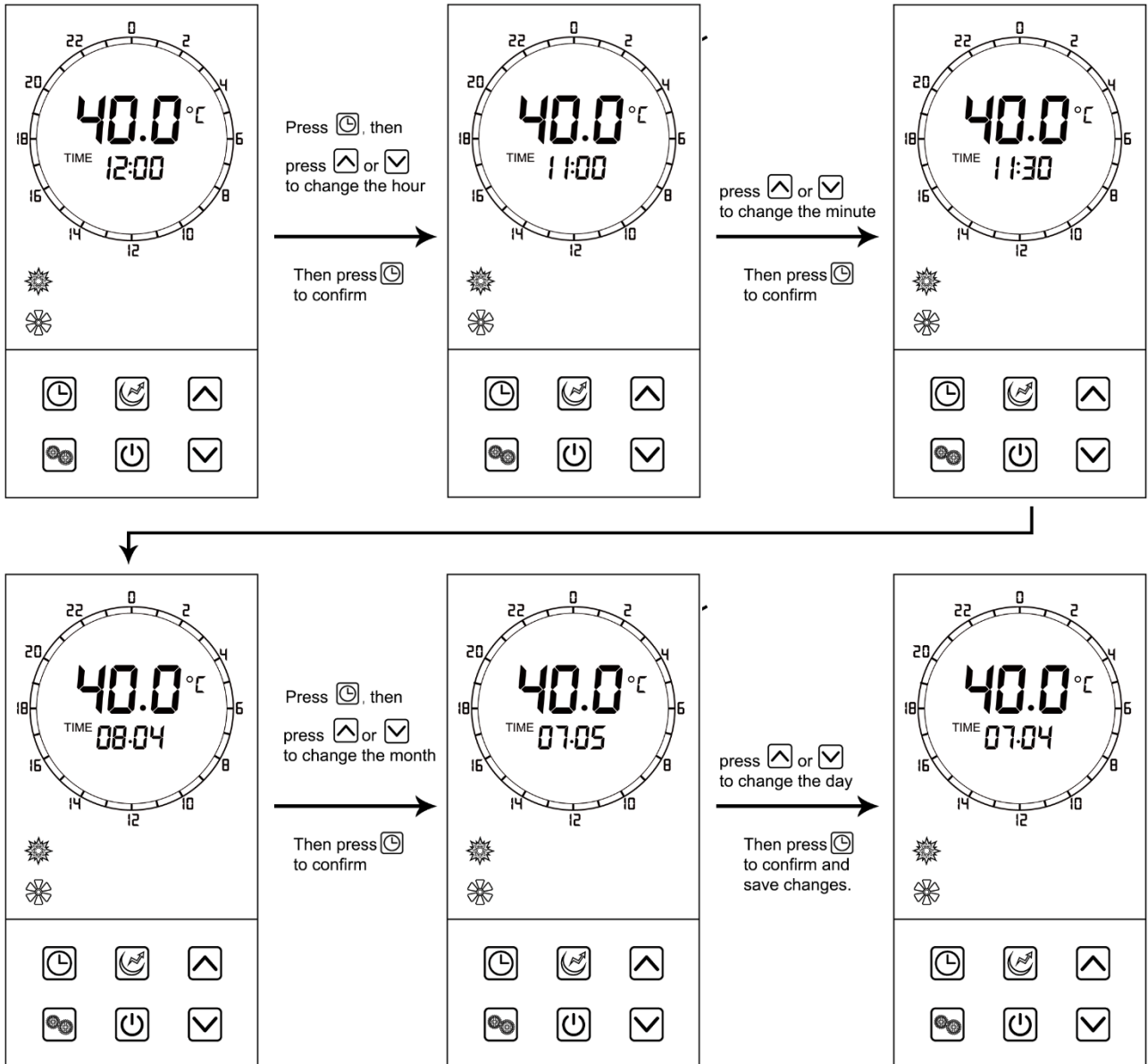

6.2.6 Setting the Timer

Timer settings can be set in standard mode, economic mode, auto mode and fast heating mode. Note: there are two types of timing settings: touch and button. The unit will run during the lit time periods and stop on the dim areas.

Touch



Press  and hold for 2 seconds (the timer display will flash)

When the timer display flashes, choose your start-up time (A) and end time (B).

Press  to save the setting and exit back to the main interface.

Button

Press  and hold for 2 seconds (the timer display will flash)

When the timer display flashes, choose the start-up time (C) and end time (D) by pressing  or  and .

Press  to save the setting and exit back to the main interface.

Example: Setting the unit to run from 7-11am & 4pm-6pm using Touch mode.

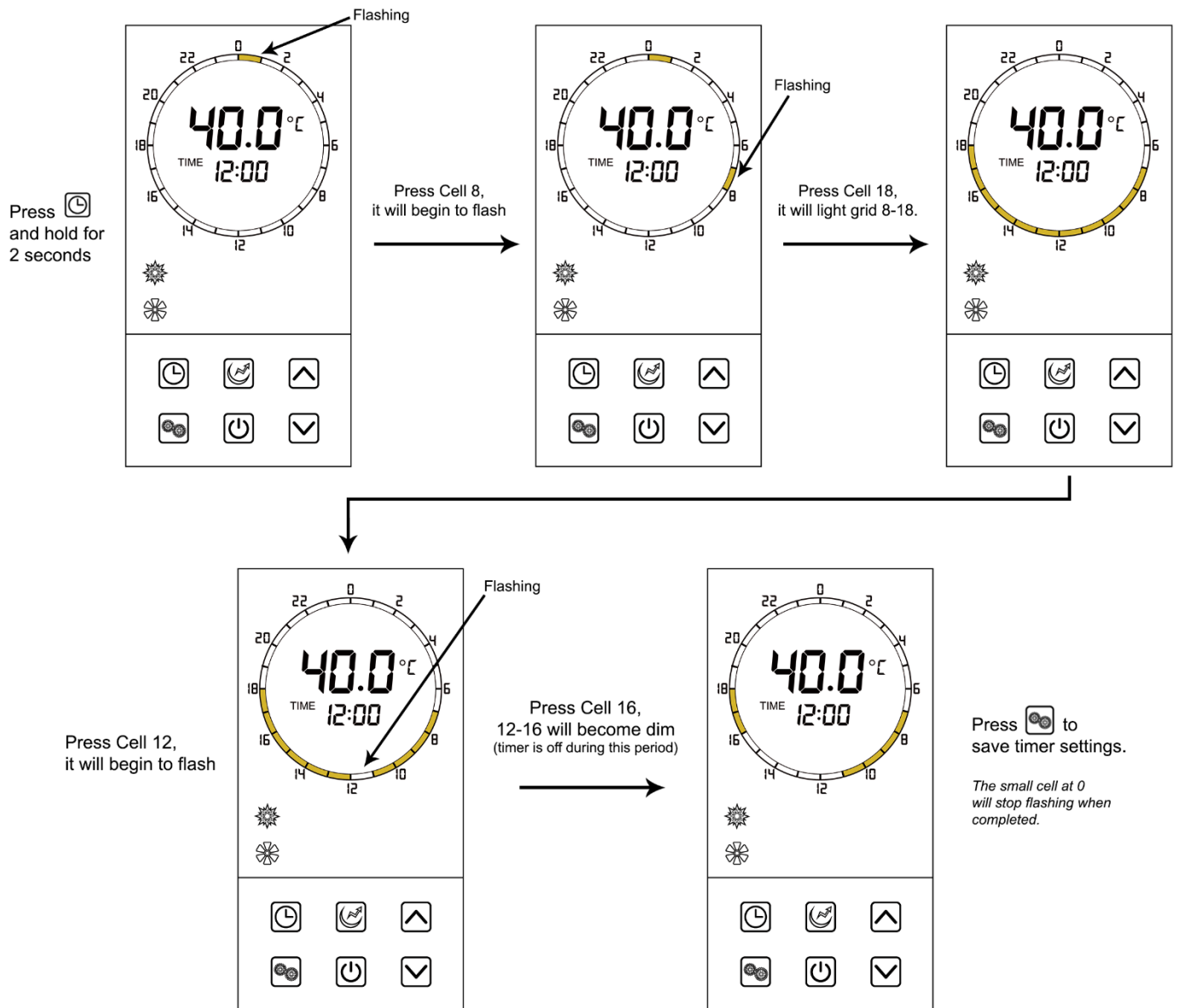

6.2.7 Cancelling the Timer

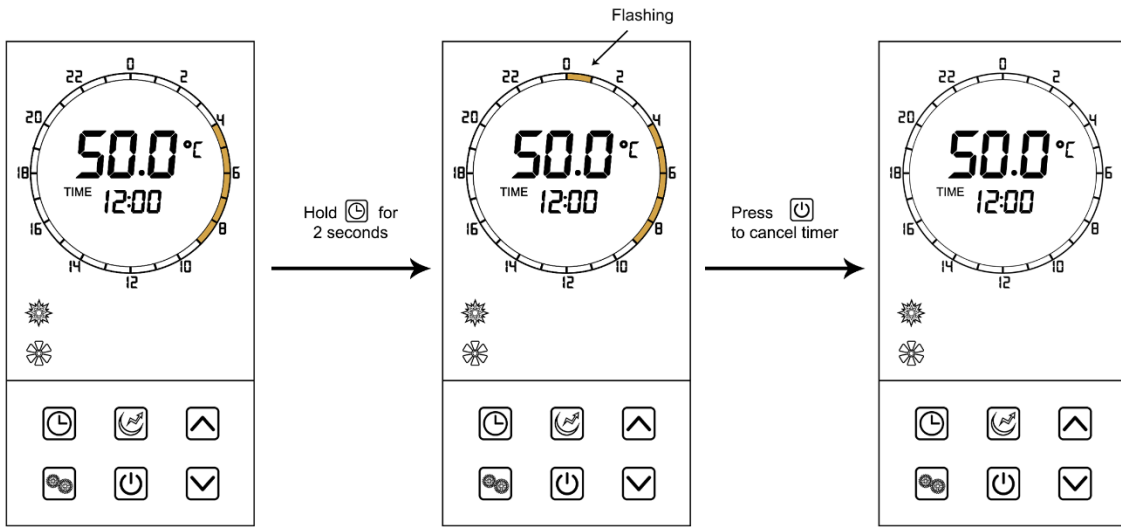

To cancel a timer once it has been set, hold down the CLOCK  button for 2 seconds until the timer display begins flashing (as you would set the timer).

Press the POWER  button while the timer is flashing to cancel it. The yellow timing periods will disappear when the timer has been cancelled.



6.2.8 Vacation Mode

Ensure the unit is 'OFF' before setting vacation mode. The date you set in this mode will determine what date the unit starts back up.



After selecting vacation mode, press and hold  for 2 seconds, the 'month' value will begin to flash in the display area. Press the UP or DOWN arrows to display the desired month, then  press to confirm and move to altering the 'day' value.

The 'day' value will flash when it is selected, use the arrow keys to select your desired start day, then press  to save all changes and exit back to the main interface.

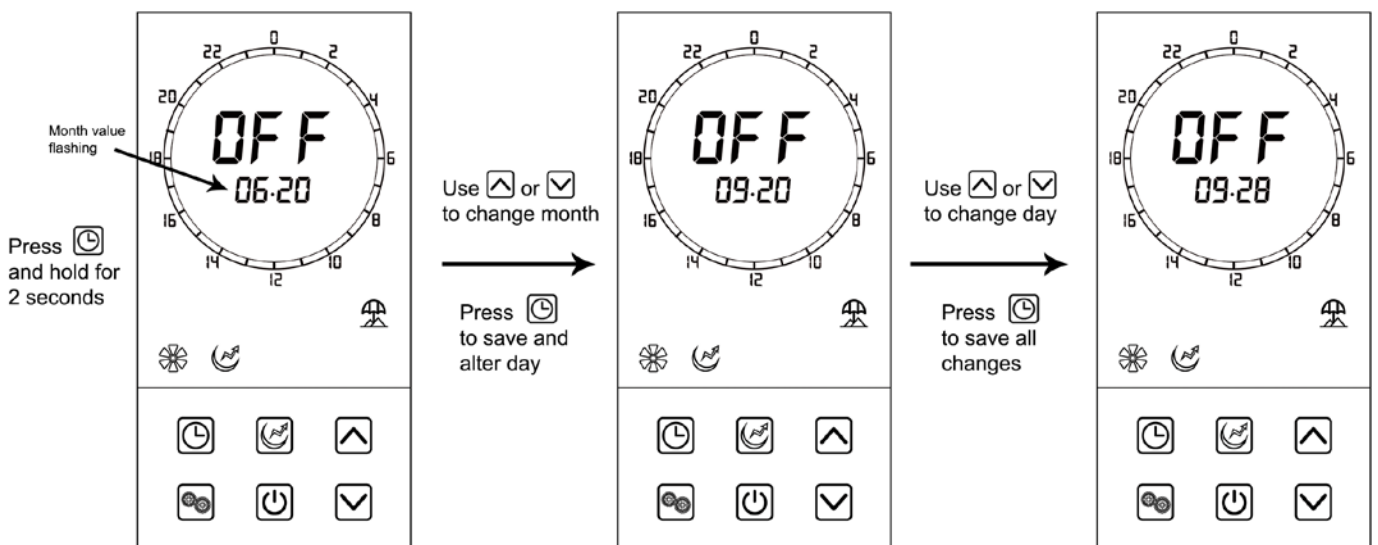
Note: Format is mm/dd
 Example: The unit will start up on September the 28th.



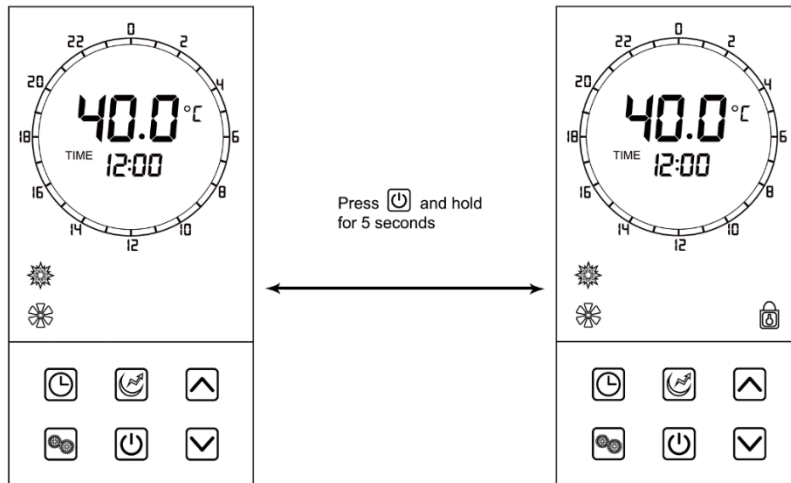

6.2.9 Keyboard Locking

Press  and hold for 5s to lock the keyboard. To unlock, press  and hold for 5s again.



6.2.10 Force Defrosting

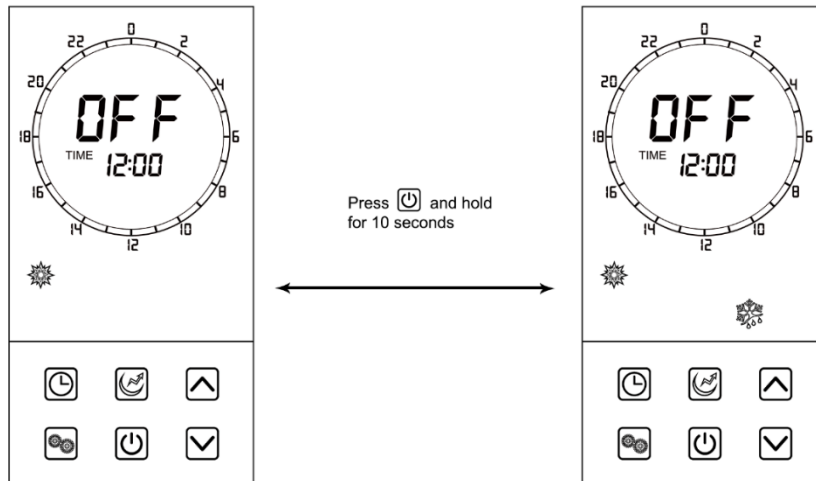

In the shutdown state, press  for 10 seconds to enable the forced defrosting function. The defrosting symbol  will light up. Press  for 10 seconds again to exit the forced defrosting function.



6.2.11 Fan/Ventilation Function

The fan speed (**High Speed, Low Speed or Off**) can be controlled by the fan mode on the controller.
 Note: when the compressor is on, the fan will always run at high speed.

When the parameter HO2 is set to 1, press the  for 2s.

Once you hear a beep you can set the ventilation mode. Press  for 2s, this will change the fan speed. Continue to press  for 2s until you reach your preferred speed.

Fan mode symbols:

 High Speed

 Low speed

Fan icon disappears: off

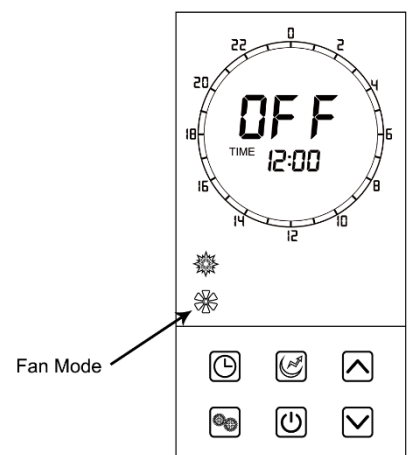

Note: When HO2 is set to 0, there is no ventilation function.

7. Troubleshooting

EvoHeat have developed a YouTube Channel where you will find useful videos regarding using the controller and potential errors. Be sure to have a look to see if the answer to your question is there:

<https://www.youtube.com/channel/evoheat>



Malfunction	Display	Cause	Solution
Bottom water temp. failure	P01	The water bottom temp. sensor is open or short circuit.	Check or change the water bottom temp. sensor
Top tank water temp. failure	P02	The water top tank temp. sensor is open or short circuit	Check or change the water top tank temp. sensor
Ambient temp. failure	P04	The ambient temp. sensor is open or short circuit	Check or change the ambient temp. sensor
Coil temp. failure	P05	The pipe temp. sensor is open or short circuit	Check or change the pipe temp. sensor
Refrigerant absorb temp. failure	P07	The evaporator temp. sensor is open or short circuit	Check or change the evaporator temp. sensor
Anti-freeze temp. failure	P09	The anti-freeze temp. sensor is open or short circuit	Check or change the anti-freeze temp. sensor
Solar temp. failure	P034	The solar temp sensor is open or short circuit	Check or change the solar temp sensor
High pressure protection	E01	The exhaust pressure is high, high pressure switch action	Check high pressure switch and cooling return circuit
Low pressure protection	E02	The suction pressure is low, low pressure switch action	Check low pressure switch and cooling return circuit
Water flow failure	E03	No water or litter water in water system	Water, check for flow volume pump failure
Electric-heater overheat protection	E04	Water flow volume not enough, water system pressure difference is small	Water, check if the flow volume system is jammed
Anti-freeze protection	E07	Water flow volume not enough, water system pressure difference is small	Water, check if the flow volume system is jammed
Communication failure	E08	Wired remote control with master signal failure	Check the connection line between the wired remote control and mother board
Winter defrost protection	E09	Ambient temperature is too low	

8. Appendix

8.1 PCB Description

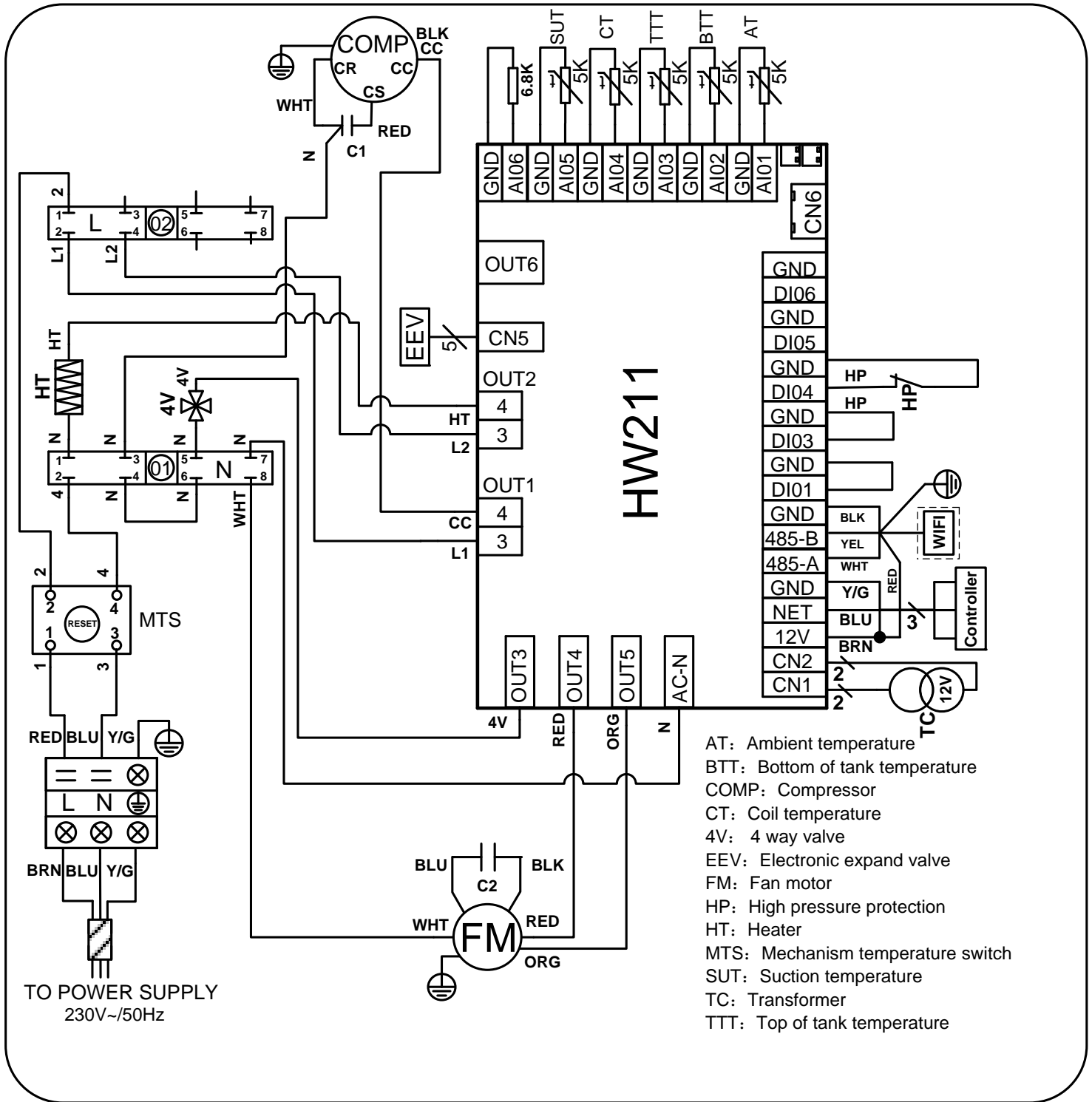

The type of fuse is 5×20_5A/250VAC

8.2 Caution

1. To reduce the risk of excessive pressures and temperatures in this water heater, install temperature and pressure protective equipment required by local codes and no less than a combination temperature and pressure relief valve certified by a nationally recognized testing laboratory that maintains periodic inspection of production of listed equipment or materials, as meeting the requirements for Relief Valves and Automatic Gas Shutoff Devices for Hot Water Supply Systems, ANSI Z21.22. This valve must be marked with a maximum set pressure not to exceed the marked maximum working pressure of the water heater. Install the valve into an opening provided and marked for this purpose in the water heater, and orient it or provide tubing so that any discharge from the valve exits only within 6 inches above, or at any distance below, the structural floor, and does not contact any live electrical part. The discharge opening must not be blocked or reduced in size under any circumstances.
2. Hydrogen gas is produced in a hot water system served by this heater that has not been used for along period of time (2 weeks or more). Hydrogen gas is extremely flammable. To reduce the risk of injury under these conditions, it is recommended that the hot water faucet be opened for several minutes at the kitchen sink before using any electrical appliance.
3. Children should be supervised to ensure that they do not play with the appliance.
4. The appliance is fitted with means for disconnection from the supply mains having a contact separation in all poles that provide full disconnection under overvoltage category III conditions, and these means must be incorporated in the fixed wiring in accordance with the wiring rules.

There should be no smoking or open flame near the faucet at the time it is open.

8.3 Earthing Methodology

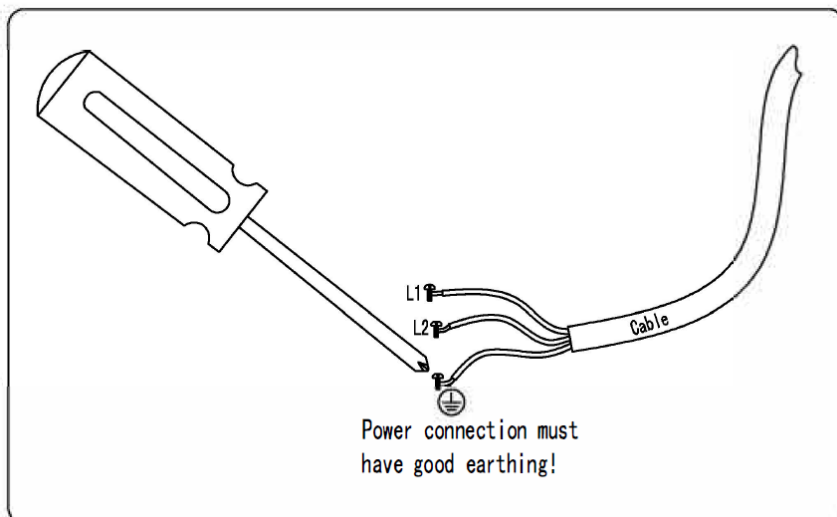

8.4 Use of the P&T Valve

The P&T valve is used to prevent the temperature or pressure becoming too high inside the tank. When the temperature or pressure reaches the set value, the valve will open automatically to force the pressure or temperature to decrease.

The handle of the safety valve should be tested once every six months to remove the calcium carbonate deposits and guarantee there is no blockage in the device. Take care to avoid burns for the temperature of the discharging water is very high.

Vent pipes should be thermally insulated to prevent safety risks caused by freezing pipes in winter.

P&T valve: Model: PTR-20, action temperature: 99°C, action pressure:0.85MPa



WARNING Fail to operate the relief valve easing gear at least once every six months may result in the water heater exploding. Continuous leakage of water from the valve may indicates problem with the water heater.

8.5 Using the Overheating Protector

Return the unit to its normal operational status it will have to be re set manually. Please contact EvoHeat for a service if this occurs.

OPERATION DETAILS

To access the overheat protector the front dark grey controller panel must be removed.

Remove the 3 screws on the front panel and push the front cover upwards.

Then remove the screws covering the overheat protector panel as below:

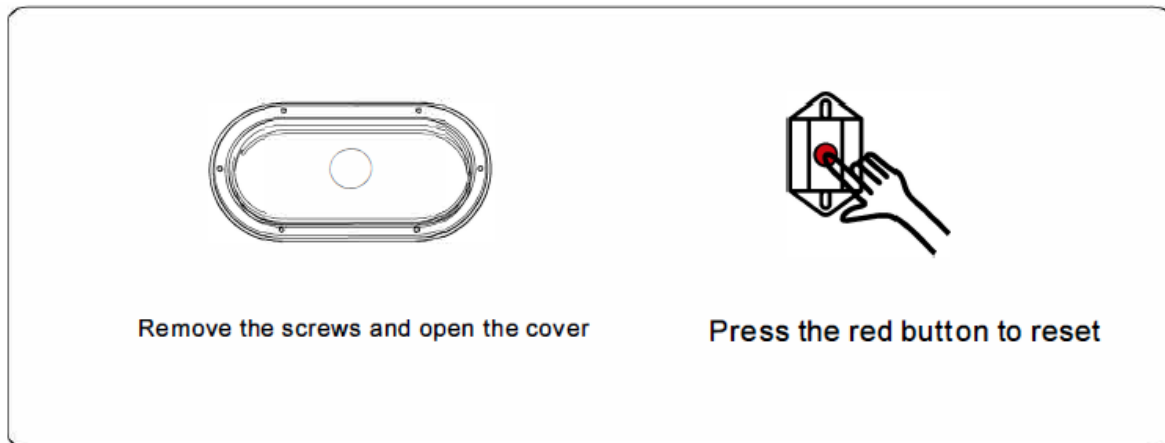

8.6 Draining the Water Tank

1. Close the cold-water inlet valve into the Evo 270.
2. Open a hot water tap inside the premises.
3. Undo the drain plug on the base of the unit to drain the water from the system.

CAUTION: THE WATER FROM THE HOT WATER TAP AND THE DRAIN PLUG WILL BE HOT. BE CAREFUL OF BURNS AND SCALDS. WEAR PROTECTIVE CLOTHING

9. Maintenance

Your Evo 270 will operate most efficiently if regularly inspected as part of your home maintenance schedule.

MINOR ANNUAL MAINTENANCE

It is recommended that the minor maintenance be performed every 12 months by the dwelling occupant.

The minor maintenance includes:

- Operate the easing lever on the temperature pressure relief valve. It is very important you raise and lower the lever gently. Exercise care to avoid any splashing of water, as water discharged from the drain line will be hot. Stand clear of the drain lines point of discharge when operating the valve's lever.
- Operate the easing level on the expansion control valve (if fitted). It is very important you raise and lower the lever gently.
- Conduct a visual inspection of all plumbing and electrical connections.
- Check the condensate drain line to ensure it is not blocked.
- Check that air vents are not blocked or obstructed, and if necessary clean with a damp cloth or air blower.
- Conduct a general external clean of the unit with a damp cloth.

MAJOR FIVE YEAR SERVICE

It is recommended a major five (5) year service be conducted on the Evo 270.

Warning: Servicing of a water heater must only be carried out by qualified EvoHeat personnel. Phone EvoHeat Service on 1300 859 933 for our closest Accredited Service Agent.

Note: The five-year service and routine replacement of any components such as the anode and relief valve(s) are not included in the EvoHeat warranty. Only genuine replacement parts should be used on this water heater.

The major service includes the following actions:

- Replace the temperature limiting valve.
- Replace the temperature pressure relief valve.
- Inspect the anode and if required, replace the anode. If the anode is not replaced, it should be replaced within three years of this service.
- Check the heating cycle of the unit.
- Visually check the unit for any potential problems.
- Inspect the plumbing and electrical all connections.
- Check the condensate on drain line to ensure it is not blocked.

Note: The water heater may need to be drained during this service. After the completion of the service, the water heater will take some time to reheat the water. Depending upon the power supply connect on, hot water may not be available until the next day.

10. Warranty



Please refer to the EvoHeat website for warranty details

- Australia: www.evoheat.com.au
- South East Asia: www.evoheat.com.sg

1. Warranty terms are from date of purchase.
2. This warranty excludes any defect or injury caused by or resulting from misuse, abuse, neglect, accidental damage, improper voltage, vermin infestation, incompetent installation, any fault not attributable to faulty manufacture or parts, any modifications which affect the reliability or performance of the unit.
3. This warranty does not cover the following:
 - a. Natural Disasters (hail, lightening, flood, fire etc.)
 - b. Rust or damage to paintwork caused by a corrosive atmosphere
 - c. When serviced by an unauthorized person without the permission of Evo Industries
 - d. When a unit is installed by an unqualified person
 - e. Where a unit is incorrectly installed
 - f. When failure occurs due to improper or faulty installation
 - g. Failure due to improper maintenance (refer Operating Instructions)
 - h. 'No Fault Found' service calls where the perceived problem is explained within the
 - i. Costs associated with delivery, handling, freighting, or damage to the product in transit.
4. If warranty service is required you should:
 - a. contact Evo Industries Australia on 1300 859 933 or via our Contact page on our web site
 - b. provide a copy of your receipt as proof of purchase
 - c. have completed the online warranty registration or provide a completed warranty card.
5. Onsite technical service is available within the normal operating area of your Evo Industries authorized Service Centre. Service outside this area will incur a traveling fee.
6. Unless otherwise specified to the purchaser, the benefits conferred by this express warranty and additional to all other conditions, warranties, rights and remedies expressed or implied by the Trade Practices Act 1974 and similar consumer protection provisions contained in legislation of the States and Territories and all other obligations and liabilities on the part of the manufacturer or supplier and nothing contained herein shall restrict or modify such rights, remedies, obligations or liabilities.

Warranty Registration

EvoHeat highly recommend customers to complete their warranty details online to ensure efficient warranty claim processing.

To register your warranty, scan our QR Code or head to our website and fill in the Warranty Registration Form: <https://evoheat.com.au/warranty-registration/>

