

INSTALLATION & OPERATING & TECHNICAL MANUAL

QUANTUM MODEL NUMBERS:

150/200-08AC6-290

270/340-08AC6-290

270/340-08AS6-290

Q U A N T U M

HEAT PUMP

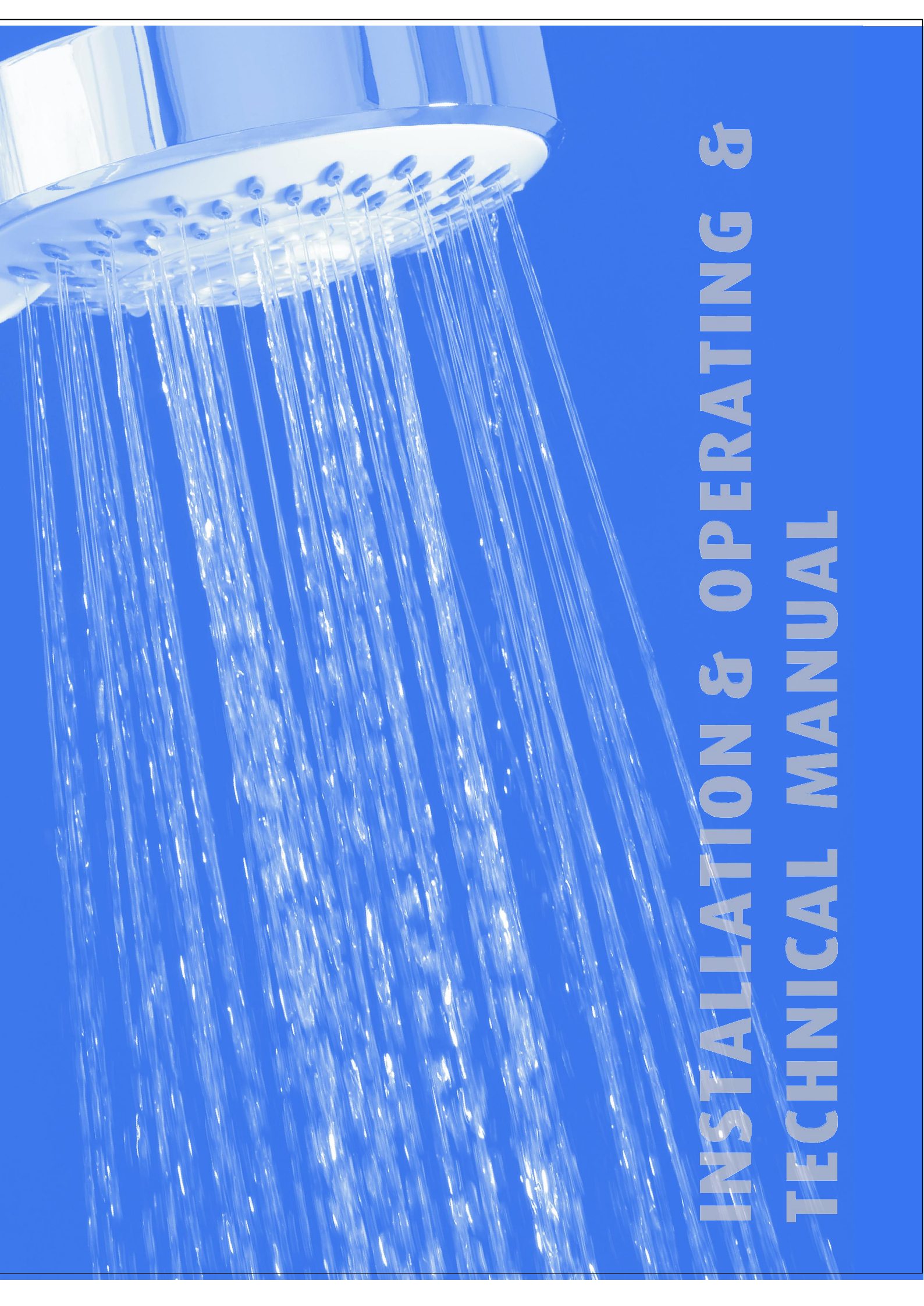

INSTALLATION & OPERATING & TECHNICAL MANUAL

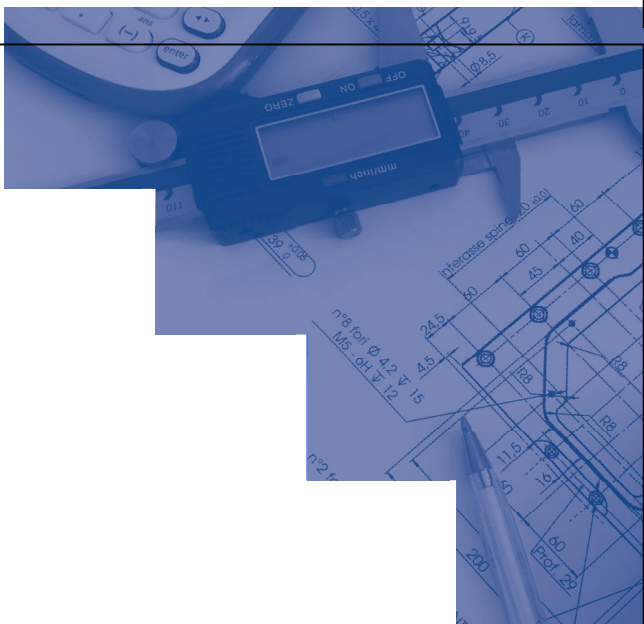

INSTALLATION & OPERATING & TECHNICAL MANUAL



AS2712 LIC.2650
SAI GLOBAL



AS3498 WMKA25313
SAI GLOBAL



INSTALLATION & OPERATING & TECHNICAL MANUAL



CONTENTS

Section 1: Appliance Details

- 1a: Owner's Details
- 1b: Installer's Details
- 1c: Service History

Section 2: Installation Details

- 2a: General Install Requirements
 - 2a1: Location
 - 2a2: Corrosion Protection
- 2b: Air Flow
- 2c: Draining of Tank
- 2d: Pressure and Temperature Relief (PTR) Valve
- 2e: Expansion Control Valve (ECV)
- 2f: Cold Water Connection
- 2g: Pressure Reducing Valve
- 2h: Caution Regarding Glass Lining of Tank
- 2i: Suitability for Installation in Frost Areas
- 2j: Hot Water Connection
- 2k: Tempering Valves
- 2l: Electrical Connection
 - 2l1: Safety Notes
- 2m: Refrigeration Connections (Split Models Only)
 - 2m1: Refrigeration Tube Sizes
- 2n: Caution Regarding Drilling the Outer Casing

Section 3: Operating Instructions

- 3a: Filling the Water Heater
- 3b: Water Quality
- 3c: Caution When Left Operating but Unused
- 3d: Instructions for Opening the Top Surroundings

Section 4: Service Information

- 4a: Thermal Overload (Incorporated in Digital Controller)
- 4b: Access & Removal of Sacrificial Anode
- 4c: Flushing of Water Tank
- 4d: Refrigeration & Thermostat Servicing

Section 5: Important Safety Instructions

- 5a: Warning
- 5b: Maintenance

INSTALLATION & OPERATING & TECHNICAL MANUAL

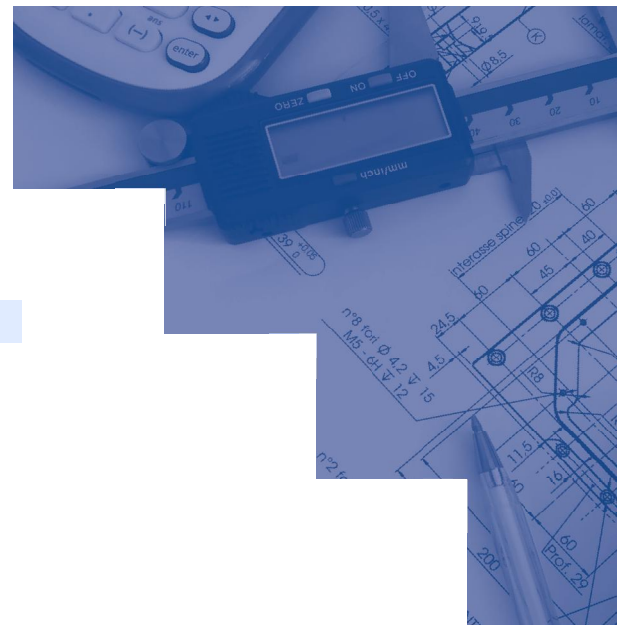

CONTENTS

Appendix A: Specifications and Dimensions

Appendix B: Wiring Diagrams

Appendix C: Trouble Shooting Guide on Quantum Water Heaters

C1: No Hot Water; Compressor Not Running

C2: Thermal Cut Out Trips off Repeatedly

C3: No Hot Water; Compressor Running

C4: Shortage of Hot Water

C5: Testing Undercharge or Overcharge of Refrigerant

C6: Water Temperature, Condensing Pressure & Amperage – R290 Units

C7: Suction Pressure – R290 Units

C8: Signs of Correct Charge

C9: Signs of Undercharge

C10: Signs of Overcharge

C11: Technical Data for Service Personnel – Compressor – R290

List of Figures:

Figure 1A: Basic Tank Layout with Recommended Valves (except Tempering)

Figure 1B: Installation Diagram

Figure 2: Specifications and Dimensions

Figure 3: Split Fin Coil Evaporators

Figure 4: Wiring Diagram 150/200/270/340-08AC6-290
270/340-08AS6-290

INSTALLATION & OPERATING & TECHNICAL MANUAL



Section 1: APPLIANCE DETAILS

For future convenience, please fill in the following details and retain with your original invoice.

1A: OWNER'S DETAILS

Surname: Given Name(s):

Address:

Town/Suburb:

State/Territory: Postcode:

Date of Purchase:

Purchased from:

Model: Serial Number:

Date of Manufacture:

(Details on the Data Plate of the water heater)

1B: INSTALLER'S DETAILS

Date of Installation: Installer's Name:

Address:

Licence number: Installer's Signature:

1C: SERVICE HISTORY

Date of Service: Serviced By:

Work Carried Out:

Signature of Service Agent:

Date of Service: Serviced By:

Work Carried Out:

Signature of Service Agent:

Date of Service: Serviced By:

Work Carried Out:

Signature of Service Agent:

INSTALLATION & OPERATING & TECHNICAL MANUAL



Section 2: INSTALLATION DETAILS

Figure 1A: Basic Tank Layout with Recommended Valves (except Tempering)

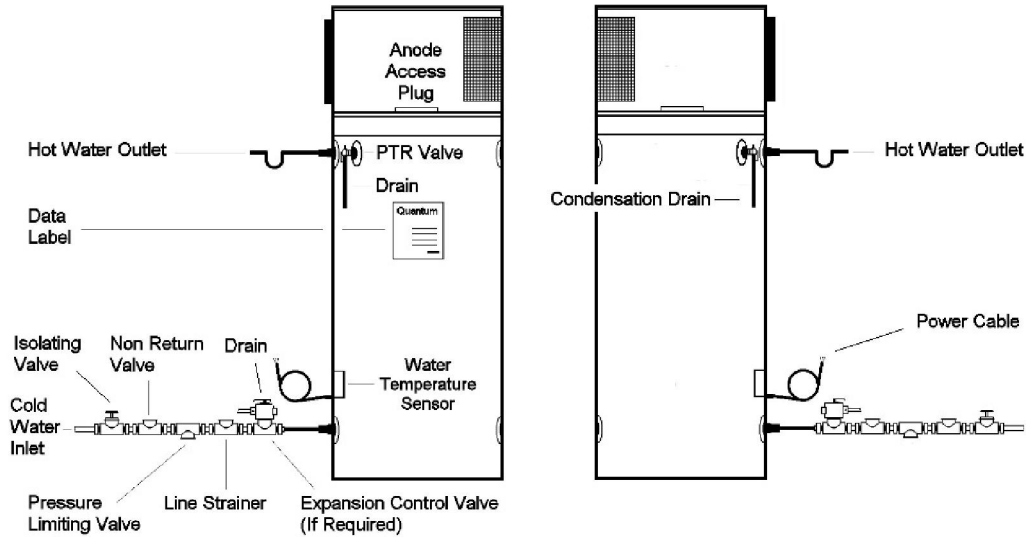
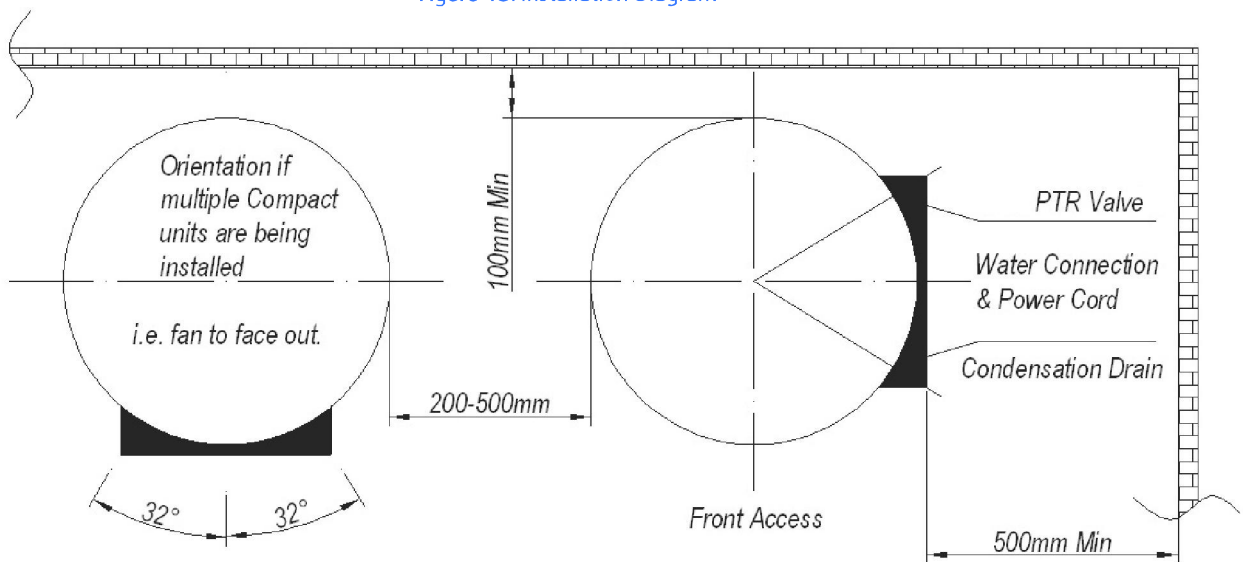

Figure 1B: Installation Diagram



Tank Orientation Diagram for Compact Units

Note: If installing multiple Compact units, the orientation of the tank will need to be at 90 degrees to the normal arrangement so that the fan points out from the wall rather than along it. This is so cold air being discharged from one unit is not drawn in by the one next to it.

The space between multiple units should be a minimum 200mm.

There are marks such as **COLD DRAIN** on the plastic pipe sockets. **DO NOT** connect to the wrong type of pipe or part.

INSTALLATION & OPERATING & TECHNICAL MANUAL



2a: General Install Requirements

This water heater must be installed by a licensed tradesperson, and in accordance with:

1. AS/NZ 3500.4 National Plumbing and Draining Code, Part 4: Hot Water Supply Systems
2. AS/NZ 3500.4.2, National Plumbing and Draining Code, Part 4.2: Hot Water Supply systems – Acceptable Solutions.
3. Installation of this water heater must be performed in accordance with AS1677.2 clause 2.6.2.
4. Other relevant Australian standards, industry or local water supply regulations or codes for mains pressure storage tanks.

***Installation within NZ must confirm to NZ Building Code G12.**

Note: This water heater is not suitable for pool or building heating.

2a1: Location

- a. The Quantum water heater must be installed outdoors.
- b. The water heater should be located as close as possible to the most frequently used hot water outlets.
- c. Adequate access must be made for service to the heat pump, water thermostat, relief valve and anode.
- d. Ensure that the specification label is clearly visible. The front service cover of the heat pump section (on top of tank) must be accessible from the front of the heater; this **MUST NOT** face the wall. The fan **MUST NOT** be up against a wall (minimum clearance 500mm).
- e. The Compact and Split model has a noise level similar to an air conditioner's outdoor unit (48dBA @ 1.5 metres); therefore locating the unit away from bedrooms or living areas is recommended (both the owner's & any neighbors).
- f. **Note: All models are equipped with a sacrificial anode, accessible through the top cover. We suggest allowing 400mm above the top of the water heater (if possible) for clearance to replace the anode.**

The water heater should be placed on a 650mm x 650mm horizontal plinth if installed on a floor subject to wet conditions or outdoors. A properly drained overflow tray should be used where property damage could occur from water spillage. (See AS3500.4 for further details.)

Note: The warranty does not cover damage due to leakage of the water heater.

2a2: Corrosion Protection

- a. Fittings and the shell surface in contact with the water are to be galvanically compatible.
- b. Sealants and/or Teflon plumbing tape should be used on potentially galvanically incompatible fittings. This is to protect against possible electrolytic corrosion between the metals (where moisture penetration could occur due to incorrectly or poorly sealed fittings and un-vertical installation).

2b: Air Flow

- a. The air source models (Compact and split) extract the required heat from air being drawn through their Fin Coil Evaporator. This produces cold exhaust air as a by-product. Therefore, good ventilation of the proposed location for the Compact models or the split models' separate evaporator is required.
- b. The Compact and Split models must be located externally. **GOOD VENTILATION IS REQUIRED.**

2c: Draining of Tank

Consideration should be given to the possible necessity of draining the tank at some point. Draining of the tank can be accomplished by the connection of a hose to the cold water inlet and running to a suitable drain. It will be necessary to disconnect the hot water outlet or PTR valve to relieve any partial vacuum created as the water flows out.

INSTALLATION & OPERATING & TECHNICAL MANUAL

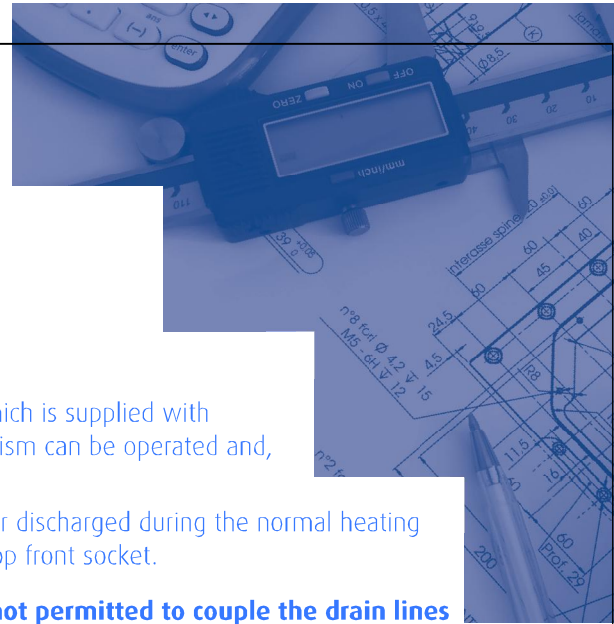

2d: Pressure and Temperature Relief (PTR) Valve

- The Pressure and Temperature Relief Valve (see tank label for rating), which is supplied with the unit, must be fitted and made accessible so that the release mechanism can be operated and, if required, the valve replaced.
- The outlet of the PTR Valve must be suitably drained to remove the water discharged during the normal heating cycle. The valve thread is RP ½"/15mm and must be installed into the top front socket.

Warning: A separate drain line must be run for this relief valve. It is not permitted to couple the drain lines from the relief valve and evaporator into a single common line. The use of a tundish under the evaporator drain with this then connected to the drain of the PTR valve is acceptable.

2e: Expansion Control Valve (ECV)

- Where an Expansion Control Valve is fitted to the cold water supply, the ECV should be rated at 150kPa lower than the Pressure & Temperature Relief (PTR) Valve.
- It is a State requirement for SA & QLD that an ECV be fitted on the cold water supply line between the non-return valve and the water heater.

2f: Cold Water Connection

- An approved isolating valve, approved non-return valve and union must be fitted between the supply main and the RP ¾"/20mm socket in the water heater.
- All fittings must be approved by the relevant Authority (refer to Fig 1).

2g: Pressure Reducing Valve

- This water heater is designed for direct connection to a maximum water supply pressure of 800kPa. Where the mains pressure can exceed or fluctuate beyond this pressure, a pressure-limiting device (complying with AS1357) must be fitted in the cold-water supply line.
- This device must be installed after the isolating valve and set at or below 500kPa (or 350kPa if an 850kPa ECV is fitted).
- An ECV is fitted when the water supply has a tendency to form scale. This type of water is referred to as scaling water because calcium carbonate is deposited out of the water onto any hot metallic surface. The fitting of an ECV is mandatory in WA, SA and some other areas of Australia as dictated by local regulations.

2h: Caution Regarding Glass Lining of Tank

- When making the hot and cold water connections to the tank care should be taken not to apply excessive strain as damage to the tank spigots or glass lining may occur.

2i: Suitability for Installation in Frost Areas

- The R 290 refrigerant used has a boiling point of -42°C. Therefore, there is no risk of damage to the heat pump from frost. Performance may be reduced in very low temperatures, but the system will not be damaged by such climatic conditions.

2j: Hot Water Connection

- The hot water pipe should be connected to the RP ¾"/20mm socket as shown in the Installation Diagram (Fig 1). If desired, a thermo siphon trap can be installed at the hot water outlet to further reduce heat loss (a "U" shaped loop will form such a trap – see Fig 1).
- It is recommended that all hot and cold water lines be insulated.
- NOTE: Plugs are supplied with the water heater to plug off the inlet/outlet entries that are not required. Ensure that adequate sealing is applied to the plugs for a tight, leak-proof seal.

INSTALLATION & OPERATING & TECHNICAL MANUAL

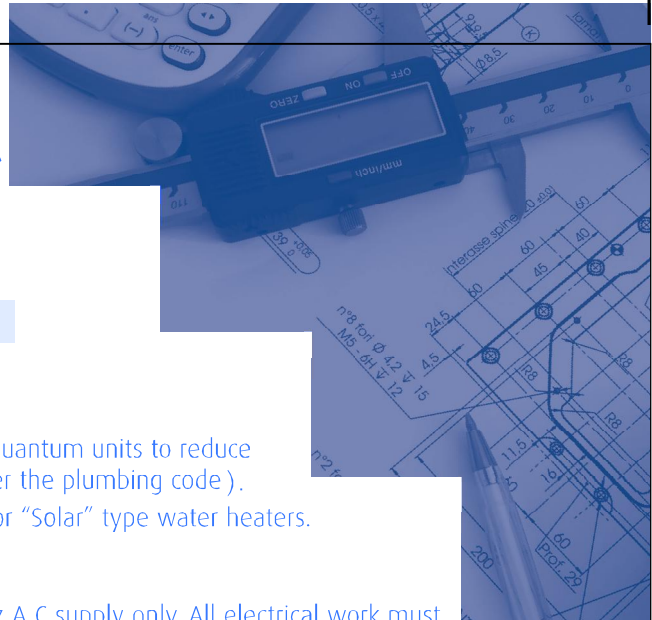

2k: Tempering Valves

- The tempering valve should be fitted on the hot water outlet of the Quantum units to reduce water temperature to the temperature designated in (e.g., 50°C as per the plumbing code).
- Quantum recommends the use of high performance valves suitable for “Solar” type water heaters.

2l: Electrical Connection

- Quantum water heaters are designed for single-phase 220-240V 50Hz A.C supply only. All electrical work must be conducted by a certified electrician according to the local regulations and AS3000. A 10 Amp circuit breaker must be installed at the power supply for hot water units up to 0.84 kW. The power connection rating for Quantum water heaters is 220-240V 50Hz A.C 10 Amp.
- A separate circuit breaker is recommended for each unit in the case of multiple installations.
- It is not recommended to wire the system to an earth leakage circuit breaker. There is lot of moisture present while in operation and this can lead to nuisance tripping.
- The connection will require an approved, standard 240V On/Off switch or Junction Box in close proximity to the heater. The unit should be connected to Standard tariff. Off Peak connection is NOT recommended for Quantum heat pump units. If the unit is connected to an “Off Peak” connection, the minimum power availability must be at least 18 hours per day.
- The fitted power cord is not to be removed; this cord should be connected with the building wiring in an On/Off switch enclosure or Junction Box. Faulty wiring may void the warranty if damage has been sustained to the compressor or heat pump from such faulty or sub-standard wiring. ***Please note that your Quantum Heat Pump is now fitted with a Digital Timer. (Not all models). For further information please contact the Quantum Service Call Centre on 1800 644 705.**

2l1: Safety Notes

Note 1: This water heater is fitted with a thermostat and over-temperature energy cut-out (both incorporated into the digital controller). Under no circumstances should the water heater be operated without both of these devices being in the circuit. Only a qualified electrician or the manufacturer should carry out replacement.

Note 2: If the supply cord is damaged, the manufacturer or its service agent or other similarly qualified person must replace it in order to avoid hazard.

Caution: The water heater must be filled with water before turning on the electricity.

2m: Refrigeration Connections (Split Models Only)

- At one side of the tank and the heat pump, there are two sets of connections (see below Pic 1) for the refrigeration circuit. Remove their protection covers and connect them as Pic 2 . Then open the globe valves on the tank and the heat pump to let refrigerant get through.
- Refrigeration pipe work is highly specialised and should only be completed by a licensed refrigeration mechanic.
- Maximum refrigeration pipe length from the tank connections to the evaporator is 10m.
- If the evaporator is mounted below the tank connection point, then a suitable oil trap needs to be installed on the suction line between the evaporator and the heat pump.

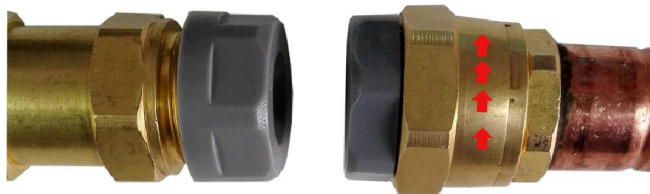

Picture 1



Picture 2

INSTALLATION & OPERATING & TECHNICAL MANUAL

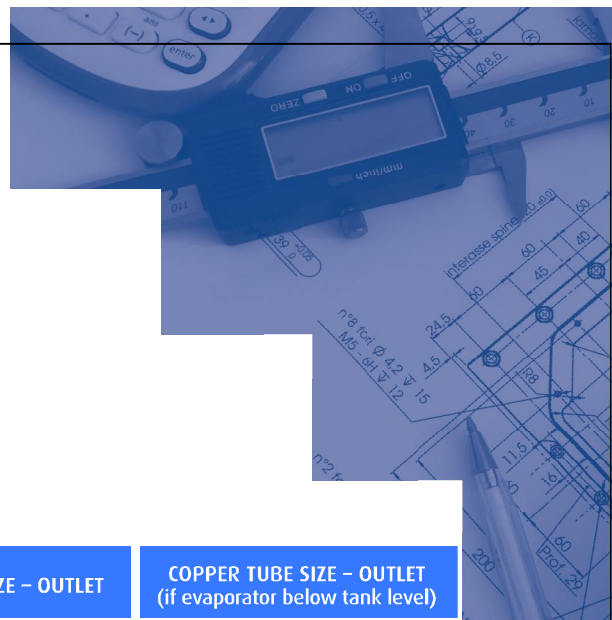

2m1: Refrigeration tube sizes

QUANTUM MODEL	COPPER TUBE SIZE – INLET	COPPER TUBE SIZE – OUTLET	COPPER TUBE SIZE – OUTLET (if evaporator below tank level)
150/200-08AC6-290	5/16 Inch (8.0mm)	3/8 Inch (9.5mm)	5/16 Inch (8.0mm)
270/340-08AC6-290	5/16 Inch (8.0mm)	1/2 Inch (12.7mm)	3/8 Inch (9.5mm)
270/340-08AS6-290	5/16 Inch (8.0mm)	1/2 Inch (12.7mm)	3/8 Inch (9.5mm)

2n: Caution Regarding Drilling the Outer Casing

This is extremely important and **MUST** be adhered to without exception!

DO NOT DRILL ANY HOLES IN OUTER METAL CASING

DRILLING OF ANY HOLES WILL VOID WARRANTY

Section 3: OPERATING INSTRUCTIONS

3a: Filling the Water Heater

Open all hot water taps. Open isolating valve at the cold-water inlet and allow the water heater to fill until water flows through the system. Close each hot water tap after the air is expelled from its line.

3b: Water Quality

Your Quantum water heater has been manufactured to suit the water conditions of most Australian and New Zealand metropolitan supplies. Harsh water supplies can have a detrimental effect on the water heater and its life expectancy. If you are unsure about your water quality you can obtain information from your local water supply authority.

By using the correct anode, this water heater can be used in areas where the Total Dissolved Solids (TDS) content of the water supply is up to 2500 mg/L.

In areas where the TDS exceeds 750mg/L it is possible that the magnesium alloy anode (supplied in the heater) may become over reactive. To alleviate this, the magnesium alloy anode should be checked more regularly, and replaced if necessary. More information is given in the **Owner's Warranty Manual section**.

3c: Caution When Left Operating but Unused

If the water heater is left in an operating condition, but unused for two weeks or more, hydrogen gas (highly flammable) may accumulate on top of the water cylinder. To dissipate this gas safely, it is recommended that:

- A hot tap be turned on for several minutes at a sink, basin or bath, but not a dishwasher, clothes washer or other appliance.
- During this procedure there must be no smoking, open flame or any other electrical appliance operating nearby.
- If hydrogen gas is discharged through the tap it will probably make an unusual sound similar to air escaping.

INSTALLATION & OPERATING & TECHNICAL MANUAL

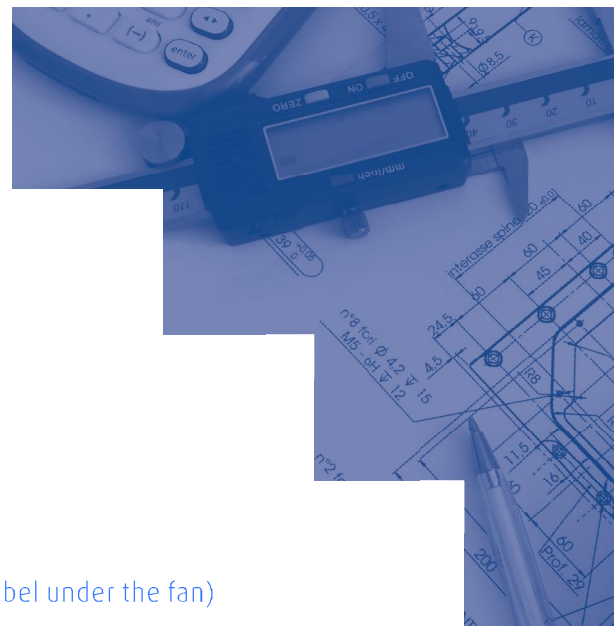

3d: Instructions for Opening the Top Surroundings

a. For the location without height limit

Step 1: Remove two labels as shown in the picture (except the label under the fan)

Step 2: Remove the upper screws (except the bottom ones)

Step 3: Remove the surroundings upwards

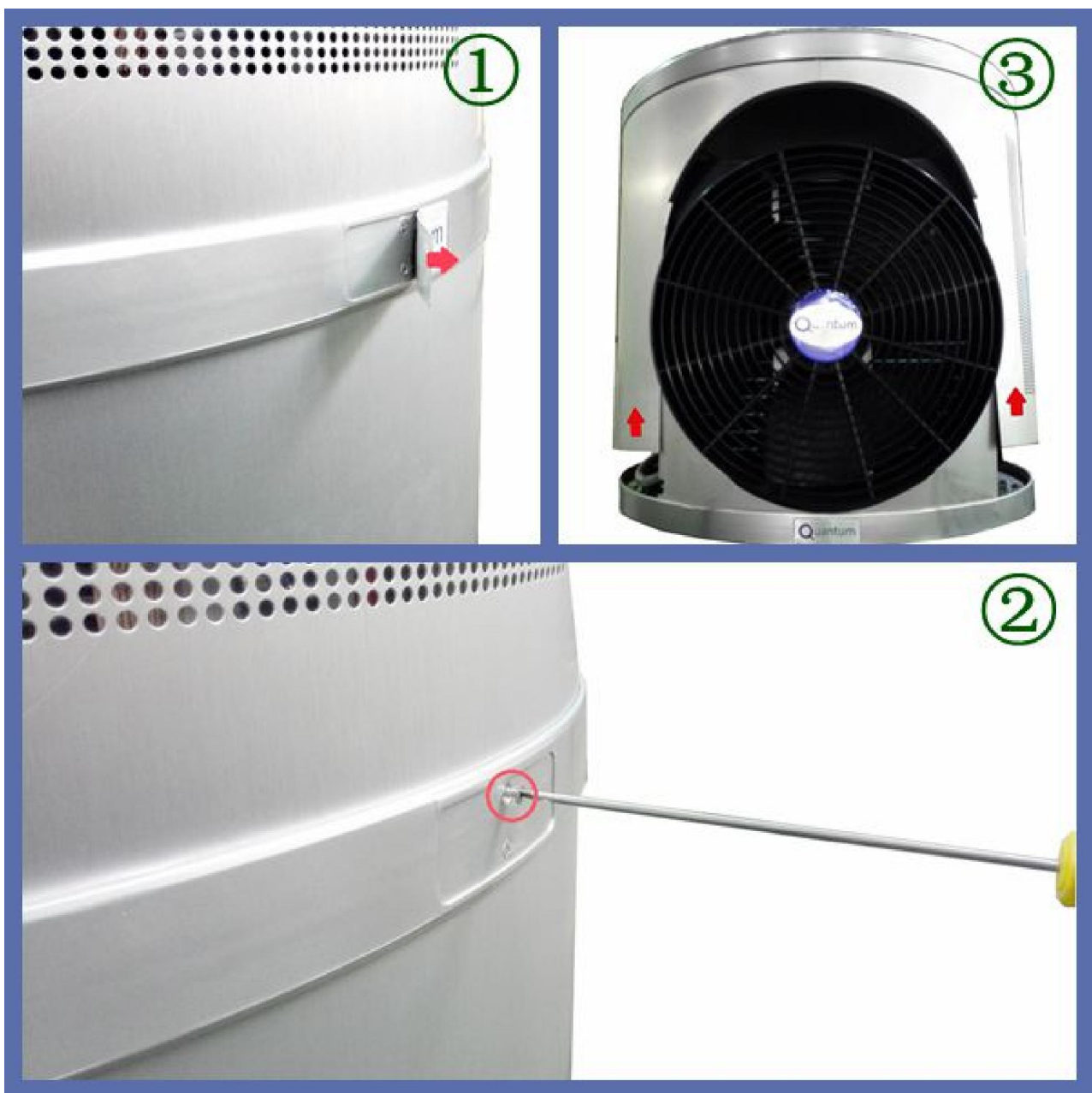

INSTALLATION & OPERATING & TECHNICAL MANUAL

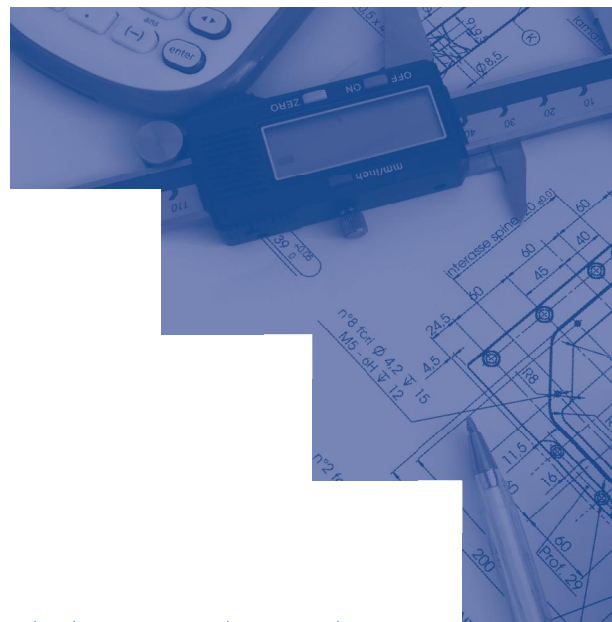

b. For the location with height limit

Step 1: Push the Top Lid upwards to remove it



Step 2: Remove both screws as shown in the picture

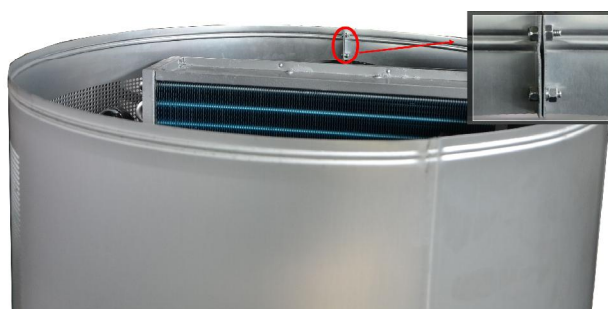

Step 3: Remove two labels as shown in the picture (except the label under the fan)



Step 4: Remove the upper screws (except the bottom ones)



Step 5: Remove the surroundings



INSTALLATION & OPERATING & TECHNICAL MANUAL

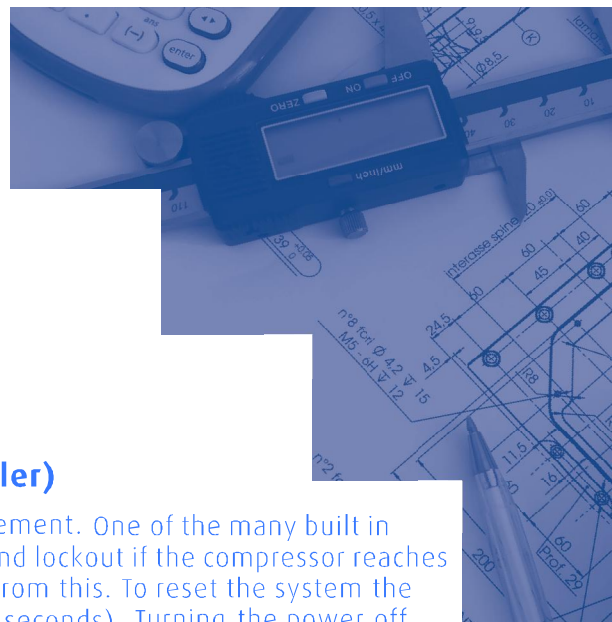

Section 4: SERVICE INFORMATION

4a: Thermal Overload (Incorporated in Digital Controller)

All models are fitted with a digital controller for heat pump management. One of the many built in safety functions of the digital controller is to initiate a shut down and lockout if the compressor reaches a temperature of 85°C. The system will not automatically restart from this. To reset the system the "SET" button on the digital controller must be pressed (hold for 6 seconds). Turning the power off then back on will also perform a reset.

4b: Access & Removal of Sacrificial Anode

The anode can be accessed via the heat pump section, to remove.

1. Turn off power to the unit, cut into water valve, open PTR valve to release pressure on the system.
2. Remove the screws around the top cover of the heat pump & remove the heat pump top cover.
3. For easier access the front inspection panel on the heat pump section should also be removed.
4. Locate and remove the plastic plug through the centre of the heat pump chassis.
5. The anode head is now accessible and can be unscrewed with a suitable $1\frac{1}{16}$ " socket wrench.
6. Once unscrewed the anode can be drawn out through the top of the tank / heat pump section.
7. The new anode can then be fitted and the heater reassembled.

4c: Flushing of Water Tank

As with other hot water heater tanks, dissolved solids in the water or scale may accumulate in the bottom of the water tank forming sludge. This is generally less of a problem with Quantum units as no internal elements or burners are used. If such sludge build-up does occur the following procedure can be followed to clean out the tank.

1. Turn Off power to the unit.
2. Turn Off water supply to the unit.
3. Remove the blanking plug (brass fitting) from the unused inlet (normally on the right hand side for left hand connected tanks) – the inlets are at the bottom of the tank 70mm up from the base.
4. Remove the blanking plug from the unused hot water outlet (normally on the right hand side for left hand connected tanks) – the outlets are at the top of the tank.
5. Allow the water to drain from tank, while the water is draining a non-metallic rod may be inserted through the open cold-water inlet and used to break up any sludge and assist in its removal.
6. Care should be exercised during this procedure so as not to damage the glass lining of the tank. The use of metal rods should not be used and plastic or wooden rods used instead.
7. Turning the cold water supply back on while the tank is emptying or after the tank has drained and continuing with the mechanical agitation will further assist with the removal of the sludge.
8. Once the tank has been cleaned, as much as possible, the cold water should be turned off again and the blanking plugs refitted. Care should be taken to ensure good a hydraulic seal is maintained – the use of plumbing tape will be required.
9. When the unit is fully reassembled the cold water supply and power supply can be turned on and the unit allowed to reheat.

4d: Refrigeration & Thermostat Servicing

Qualified refrigeration technicians only should service the heat pump. The information provided in **Appendix C: Trouble Shooting Guide** will provide the necessary information for qualified personnel to service this part of the unit. If the refrigeration line is to be opened or charged, the service agent/technician must hold the relevant Gas Works Authorization - Hydrocarbon Refrigerants accreditation.

INSTALLATION & OPERATING & TECHNICAL MANUAL

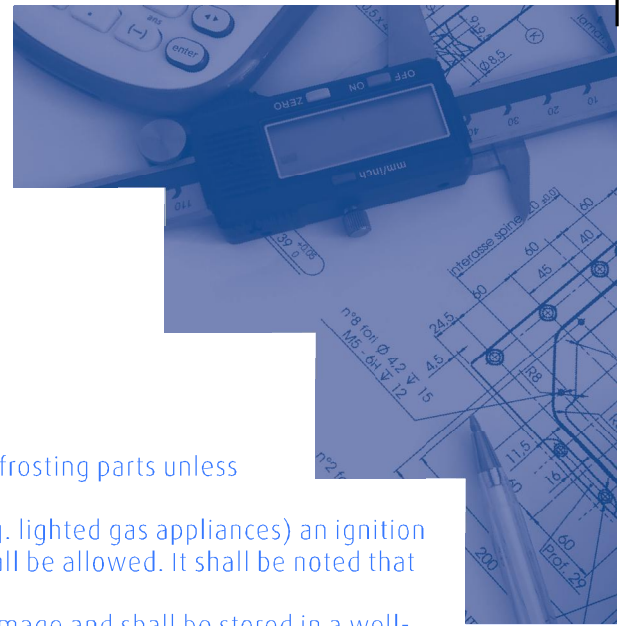

Section 5: Important Security Instructions

5a: Warnings

Do not use any method to accelerate the defrosting process or clean the frosting parts unless recommended by manufacturers.

Appliances shall be stored in place absence of sustained fire sources (e.g. lighted gas appliances) an ignition sources (such electric heater under working), nor piercing or igniting shall be allowed. It shall be noted that the refrigerant may be out of smell.

Piping components shall be protected in order to prevent mechanical damage and shall be stored in a well-ventilated room, whose size shall meet the maintenance requirements.

All qualified workers or cooling loop maintenance personnel shall meet industry-recognized assessment specification requirements in terms of disposal of refrigerants.

Maintenance and repair of equipment shall be in accordance with the manufacturer's recommendation. If additional assistance of other professionals in maintenance and repair is needed, it shall be under qualified personnel supervision.

5b: Maintenance

1 check on site

Prior to the maintenance of flammable refrigerants appliance, security checks shall be carried out to ensure to minimize the risk of fire occurrence. When repairing refrigeration system, the following key issues shall be noted as well.

2 operating procedures

Work should be carried out under controlled procedures to ensure the lowest risk by flammable gases or vapors arising during the operation.

3 general work areas

All maintenance personnel in the work area shall be aware of the nature of the job. Do not operate in the sealed space. Working area should be properly isolated to control combustible materials so as to ensure safe operation within working conditions.

4 refrigerant detection

Before and under working process, refrigerant shall be detected with appropriate detector in the region to ensure that technical staff are aware of combustible gas leak potential. And make sure that detector is suitable for flammable refrigerant leak : no spark, seal or essential security.

5 extinguisher

When the refrigeration system or related components are under heat processing operations, it shall be noted that dry powder or carbon dioxide fire extinguisher shall be placed nearby.

6 prohibit of the fire source

Engaged with or exposed to flammable refrigerant pipe related work, it shall be noted that none form of fire source may cause a fire or explosion hazard shall be used, including smoking. If flammable refrigerants was released into the surrounding environment ,make sure to stay away from installing, repair, shift and disposal regions. Before starting the work, make sure the surrounding environment exists no flammable fire hazard source. No -smoking tag shall be posted.

7 ventilated area

Make sure the work area is adequately ventilated before opening the system or operating thermal processing. Enough ventilation shall ensure the leaking refrigerant to release into the atmosphere safely and rapidly.

Sparks may result in explosion, fire or burning.

This product uses natural hydrocarbon refrigerants (R290) as an environmentally friendly refrigerant, so even a small amount of leakage can also cause a fire. During transport, installation or use, please be careful not to damage any device cooling circuit . Refrigerant ejected from the piping can cause burn or eye injury. Sparks may result in explosion, fire or burning. If leaks occur, eliminate open flames or potential sources of ignition and ventilation (only suitable for the R290 model). The electrical equipment should not be placed under the unit or where refrigerant could gather in the event of a leak.

In order to prevent the combustible gas mixture in case of leak in the cooling circuit, the refrigerant quantity should be determined by the amount it is needed. The usage of refrigerant displayed on machine identification card inside. Do not open the device when it shows damaged signs. Consult your distributor if any doubt occurs.

According to the relevant waste electrical and electronic product recycling laws and regulations, consumers shall pass on scrap appliances to distributors or service organizations to dispose, and are not allowed to discard appliances themselves. Disposal process shall comply with national environmental protection, labor safety and personnel health requirements.

INSTALLATION & OPERATING & TECHNICAL MANUAL

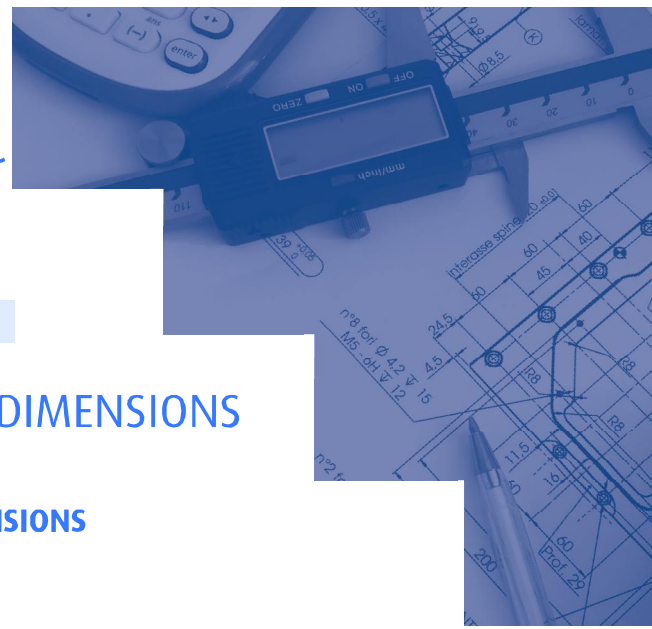

Appendix A: SPECIFICATIONS AND DIMENSIONS

FIGURE 2 : SPECIFICATIONS AND DIMENSIONS

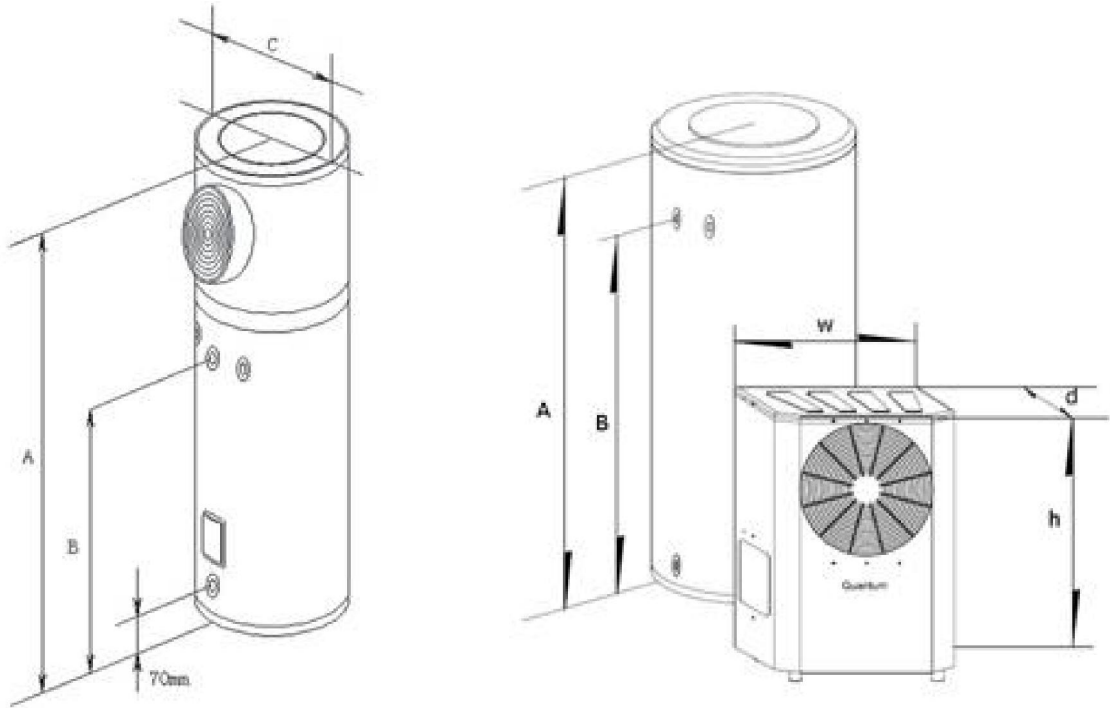

Model Number	Mass (Empty) (Kg)	Mass (Full) (Kg)	R290 Charge (gm)	Dimensions(mm)						Power Input (W)	Nominal Capacity (Lt)
150-08AC6-290	100	250	710	1620	975	540	-	-	-	840	125
200-08AC6-290	115	315	710	1950	1305	540	-	-	-	840	175
270-08AC6-290	135	405	1030	1900	1190	650	-	-	-	840	250
340-08AC6-290	170	510	1030	2200	1490	650	-	-	-	840	315
270-08AS6-290	140	415	1030	1370	1140	650	570	880	275	840	250
340-08AS6-290	175	515	1030	1730	1490	650	570	880	275	840	315

Mobel	Evaporator Fan Noise @ 15 mtr	Air Flow Litres/Second
150/200-08AC6-290	50dBA	415
270/340-08AC6-290	48dBA	550
270/340-08AS6-290	48dBA	550

INSTALLATION & OPERATING & TECHNICAL MANUAL

FIGURE3 : SPLIT EVAPORATOR – FINNED COIL

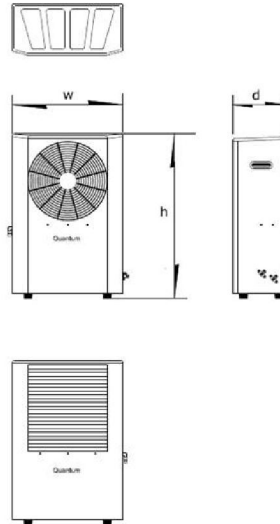

Model	Dimensions(mm)		
	W	H	D
270-08A56-290	570	880	275
340-08A56-290	570	880	275

A Quantum Technician or an accredited qualified refrigeration technician must install the Split Finned model. Whilst the plumbing and electrical work is the same as the Compact, this unit also requires on site refrigeration work.

Appendix B: WIRING DIAGRAMS

**FIGURE4 : WIRING DIAGRAM: 150/200/270/340-08AC6-290
270/340-08A56-290**

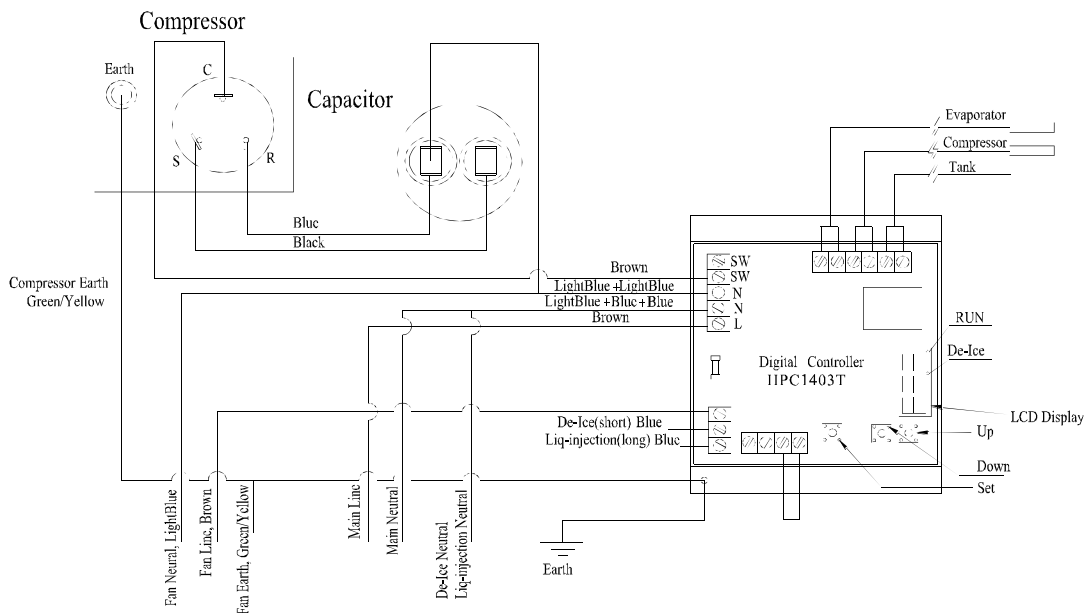

INSTALLATION & OPERATING & TECHNICAL MANUAL

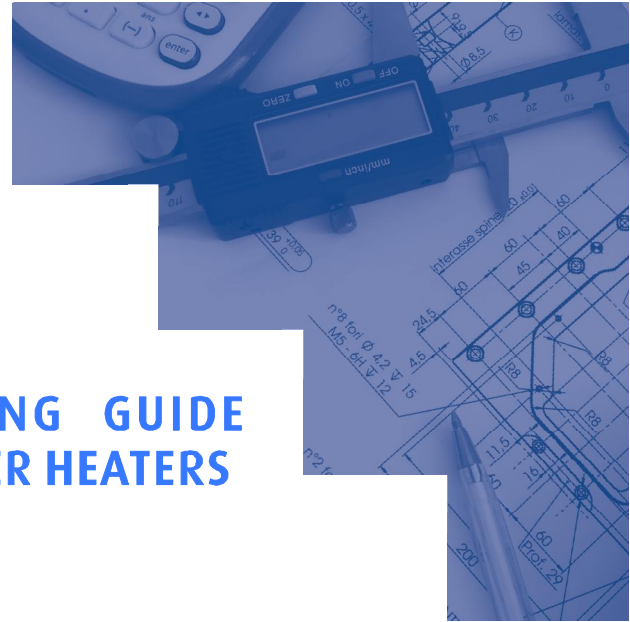

Appendix C: TROUBLE SHOOTING GUIDE ON QUANTUM WATER HEATERS

Models covered in this guide:

840 Watt. Compact Air Source Hot Water Heater (0.84kW compressor models):
150/200/270/340-08AC6-290,270/340-08A56-290

C1: No Hot Water; Compressor Not Running

Probable Cause	Test / Observation	Action
1. Power Failure	Check power supply, cable & connections.	If CB off refer to 2.
2. Circuit Breaker (CB) tripped off	Check Short Circuit (SC) in line or wiring. If Circuit Breaker is tripped off when Compressor re-starts, check Compressor grounding and winding resistance.	Remove line or wiring SC. Replace Compressor if SC found
3. Faulty / Incorrect	Check Capacitor operation if Compressor not starts.	Replace faulty or wrong Capacitor.
4. Compressor Seized	Compressor will not start with high current draw and mechanical noise	Check the voltage. Hit Compressor gently by a wood hammer. Replace Compressor.
5. Thermal Cut Out (TCO) on Digital Controller tripped off	No power to Compressor after Thermal Cut Out (TCO). If TCO trips off repeatedly, see table "A2".	Reset the TCO by pressing the "SET" button on the Digital Controller. Check the Gas amount from Sight Glass.
6. Faulty Water Thermostat	Thermostat did not cut in even though Water Temperature is below the restart point. Electrical disconnection at the Thermostat.	Check / Replace Water Thermostat or Digital controller. Reconnect or Replace if faulty.
7. Compressor Cut Out on Current overload Protector	Test for faulty Capacitor. Test for Compressor Short Circuit	Replace faulty Capacitor Replace Compressor if faulty

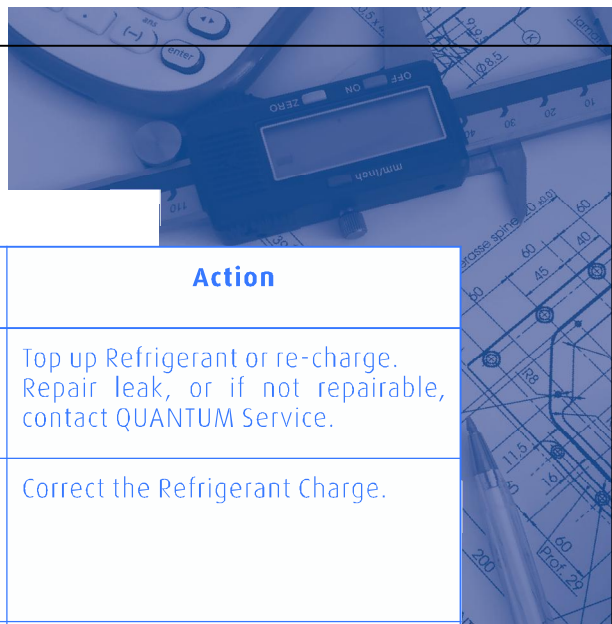

C2: Thermal Cut Out Trips off Repeatedly

Probable Cause	Test / Observation	Action
1. Low Refrigerant Charge.	Check Refrigerant Charge. Test for possible leak in the Refrigeration Circuit.	Top up Refrigerant or re-charge. Repair leak, or if not repairable, contact QUANTUM Service.
2. High Refrigerant Charge.	Check Refrigerant Charge. Over charge causes high current draw and excessive head pressure results in a hot compressor.	Correct the Refrigerant Charge.
3. Incorrect Voltage and Frequency.	Check Power Supply quality while Unit is running.	Rectify improper Power Supply or shut off system and report to the client.
4. Compressor runs hot: Internal leakage. High Suction Superheat. High Current Draw. High Head Pressure. Thermal Cut Out faulty. De-ice Solenoid remains open.	Observe Compressor operation: pressure delivery, noise. Check Gas amount (Gas Leakage), check TX valve settings (closed too much), or check TX valve element (leakage). Check Refrigerant over charge, TX valve open too much, Compressor winding resistance or mechanical fault in Compressor Rotors or Valves. Check high condensing temperature due to: I) the Thermostat Sensor does not contact the tank well, or II) faulty Water Thermostat / Digital controller, which does not cut off or III) restriction, blockage in Condenser or Filter/Drier or IV) poor heat transfer to Tank - possibly insulation material entered the space between Condenser Coil and Tank. Check correct operation of Digital Controller. Check faulty De-ice Solenoid parts or Thermostat. Check	If faulty, replace the Compressor. Find out and fix the leaking spot and charge the right amount of Gas. Open TX valve 1/4 each step and have observation. Replace TX valve. Adjust Gas charge if needed. Close TX valve if needed, or replace Compressor if it is faulty. I). Make the Sensor contact the Tank well. II) Replace faulty Water Thermostat / Digital Controller. III) If restriction is not removable replace blocked part. IV) Replace Tank. Replace Digital Controller if faulty. Replace faulty de-ice parts. Correct wiring.
5. Poor Oil return to Compressor.	Check Oil Traps in the tubes between Evaporator and Tank.	Rectify installation defects

C3: No Hot Water; Compressor Running

Probable Cause	Test / Observation	Action
1. Tank water drawn off - Unit only recently	Wait until water is heated.	If water is not heated in the expected time, check for other reasons like short of Gas.
2. Low or No Refrigerant	Check for shortage of Refrigerant or leakage in the system.	Refer to Table A.2: Item 1
3. Compressor not compressing	<ul style="list-style-type: none"> a. Check for internal valve leak. When shut off, Gas will go back through the Compressor making noise and vibration. b. Minimum pressure difference across Compressor due to TX valve malfunction (open too much). Test TX valve. 	<ul style="list-style-type: none"> a. Replace Compressor if faulty. b. Adjust (close) or Replace TX valve.
4. Frozen Evaporator	<ul style="list-style-type: none"> a. Malfunction of de-ice system or persistent cold weather resulting in poor performance of the fan Coil Evaporator. b. Blocked Evaporator. c. Restricted Airflow. 	<ul style="list-style-type: none"> a. Repair or replace de-ice system or avoid running in constant cold weather. b. Repair blockage or replace parts. c. Clean or replace Air Filter (if fitted), or clear blockages on the air ways.

C4: Shortage of Hot Water

Probable Cause	Test / Observation	Action
1. System under sized	Check actual load with design load.	Re-size.
2. Unexpected load or weather condition	<ul style="list-style-type: none"> a. Check excessive hot water draw. b. Check no water leakage. c. Check heat loss if the heater is on reticulation circuit. 	<ul style="list-style-type: none"> a. Re-size if extra hot water draw is to be included in the design. b. Repair leakage if found. c. Re-size with heat loss included in the design or install
3. System not producing enough	Check according to Table A.3: item 2, 3 & 4.	See Table A.3: items 2, 3 & 4.

C5: Testing Undercharge or Overcharge of Refrigerant

Unlike normal refrigerating or air conditioning systems, the QUANTUM heat pump operates under a very wide range of evaporating and condensing temperatures. To identify undercharge or overcharge of refrigerant gas in the system, three parameters need to be checked.

1. Current Draw
2. System Pressures
3. Bubbles through Sight Glass on the Receiver / Filter-Dryer



C6: Water Temperature, Condensing Pressure & Amperage – R290 Units

Water Temperature	Approx. Discharge Gauge Pressure		Nominal Current Draw (Varies with Evaporating Temperature)
	In Tank °C	kPa	
			840 Watt Compressor Code QXD-C184A030A
30	1150-1250	167-181	2.8-3.0A
40	1450-1600	211-233	3.4-3.6 A
50	1800-1900	262-276	3.9-4.1 A
55	2050-2100	298-305	4.2-4.4 A
60	2180-2250	316-327	4.5-4.6 A

C7: Suction Pressure – R290 Units

Typical Suction Pressure (Back Pressure – Low Side)			
Ambient Temperature °C	Evaporator Temperature °C	kPa	PSI
15	10	445	64.7
20	12	480	69.8
25	14	515	74.9

C8: Signs of Correct Charge

During normal operation with the correct amount of refrigerant gas, the sight glass should show clear liquid. A very few small bubbles may be present when the system is started or when the TX valve opens quickly. But it should return to clear liquid shortly after. Current draw and delivery pressure will be within the nominal range and temperatures should be consistent with gas properties. Correct amount of charge is listed in the Table A10.

C9: Signs of Undercharge

When bubbles through the sight glass persist for a significant time or repeat frequently then it is a sign of refrigerant undercharge. This can be confirmed by a low current draw together with low pressures. Note that unusual current draw could also be a sign of other defects in the system. If the sight glass shows clear gas (not liquid), current draw is too low and discharge gas is not hot or suction pressure is too low then the system is nearly or totally empty.

Note that low suction pressure could also indicate a blockage in low-pressure side or a closed TX valve.

C10: Signs of Overcharge

Continuous liquid through sight glass: Assuming TX valve is functioning normally, evaporator tends to flood, head pressure tends to be high, current draw is high and compressor is noisy.

C11: Technical Data for Service Personnel – GREE Compressor – R290

Parameters	150/200-08AC6-290	270/340-08AC6-290	270/340-08AS6-290
TX Valve & Setting	Danfoss TDE1 068X3071 5 turns clockwise from full open	Danfoss TDE1 068X3071 4 1/2 turns clockwise from full open	Danfoss TDE1 068X3071 4 1/2 turns clockwise from full open
Winding Resistance	C-R: 2.85Ω,C-S: 4.66Ω	C-R: 2.85Ω,C-S: 4.66Ω	C-R: 2.85Ω,C-S: 4.66Ω
Run Capacitor	30μF (+10, -5%) 450VAC	30μF (+10, -5%) 450VAC	30μF (+10, -5%) 450VAC
Rated Power Supply	220-240VAC, 50Hz	220-240VAC, 50Hz	220-240VAC, 50Hz
Rated Circuit Breaker	1Φ, 10A	1Φ, 10A	1Φ, 10A
De-ice Control Setting	On -1°C, Off +8°C (Timed De-icing)	On -1°C, Off +8°C (Timed De-icing)	On -1°C, Off +8°C (Timed De-icing)
Liquid Injection Capillary	ID 1.1mm x 1.5m (Part Models without)	ID 1.1mm x 2.9m (Part Models without)	ID 1.1mm x 2.9m (Part Models without)
Liquid Injection	On at 85°C, Off at 75°C	On at 85°C, Off at 75°C	On at 85°C, Off at 75°C
Water Temperature Setting	58°C/8°C (Del. ≥60°C)	58°C/8°C (Del. ≥60°C)	58°C/8°C (Del. ≥60°C)
Refrigerant Charge	710g	1030g	1030g
Thermal Cut Out Setting	85°C, manual reset	85°C, manual reset	85°C, manual reset

