



**Government
Rebates Available**

▶ DETAILS INSIDE

SOLAR HEAT PUMPS

**Innovative, Energy Efficient Water
Heating Technology**

ABOUT US

Why Choose Quantum?

The Quantum story is based on innovation and the quest to harness renewable energy to produce sustainable hot water.

The origins of the company go back to the mid 1970's when extensive research work was undertaken by the University of Melbourne in the development of heat pump technology for the production of hot water. Today this patented technology is used in thousands of Australian homes as well as commercially in Australia, New Zealand, Asia and Europe.

With over 30 years of on-going product development, Quantum are the experts in Solar Heat Pump water heating. Our products have been tried and tested to perform reliably and efficiently throughout Australia, in even the harshest water and weather conditions.

Did you know?

Hot water heating accounts for about **23% of your homes' total energy usage**, and is the second highest contributor to your annual electricity bills, using more energy than almost all of your other domestic appliances combined.¹

The largest range of Solar Heat Pumps in Australia.

With the largest range of compact heat pumps available in Australia, Quantum has a solution for your home or commercial project.

Our extensive range of products can service single bedroom/bathroom residences, right through to multi-level offices, hotels, motels, resorts, recreational facilities, retail outlets; and everything in between. We can also tailor a solution for your specific commercial applications.

Water heating is the largest source of greenhouse gas emissions from an average Australian home and the second largest segment of household energy use in Australia, after space heating and cooling.¹

By installing the most appropriate and efficient water heater for your household size, water use patterns and climate you can save money and reduce greenhouse gas emissions without compromising your lifestyle.²

Most people are aware of three ways to generate hot water in their home or business – electric, gas or conventional solar (with roof panels and a booster element); but there is a fourth, and it's one of the most efficient hot water systems available – the Quantum Solar Heat Pump.

Installing a Quantum heat pump system is almost identical to installing a regular electric hot water system. There are no roof panels or additional components, meaning an easy, trouble-free conversion from electric hot water to sustainable and reliable solar hot water for your home.

Our commitment to on-going product development and customer service ensures that Quantum remains the number one choice when it comes to Solar Heat Pump hot water.

¹ Australian Government, *Your Home – Australia's guide to environmentally sustainable homes* (2013)

² DCCEE 2012

FEATURES

Quantum Domestic and Commercial Heat Pumps



Suitable for use in harsh water quality conditions

The water does not make contact with any operational components, only the inner lining of the tank.



No booster element

Quantum heat pumps operate in ambient temperatures as low as -10°C . No booster element, means less energy consumption.



Low noise rating

Ultra quiet operation as low as 48dB – less than an average split system air conditioner.



Government rebates

Eligible installations attract a substantial energy efficiency cash rebate.



Solar without the panels

Hot water from solar energy, without the need for direct sunlight or roof panels. Heat pumps generate hot water day and night.



Patented Tank Wrap™ design

Quantum's patented wrap design offers one of the fastest hot water recovery rates in the heat pump market.



Easy installation

A compact design resulting in reduced labour and installation costs.



Save on power bills

Can cut up to 70% of running costs compared to some electric storage units.

What Rebates are Available?

There are a number of government initiatives designed to encourage the use of energy efficient products including the use of Quantum Heat Pump hot water services.

Small Scale Technology Certificates

Every Quantum Heat Pump installed is eligible for a rebate under the Federal Government Small Scale Technology Certificate Scheme (STCs). For a product to be eligible, it is required to undertake independent testing to determine just how efficient it is. It is then awarded a number of energy efficiency certificates (STCs) based on this result.

The number of STCs a product is awarded is a direct representation of how much energy the system will save over a 10 year period, compared to a conventional electric water heater. The higher the STC rating, the more efficient the system, and the more you'll save in electricity.

STC Rebate Value Calculations

The final dollar value of an STC rebate depends on a heat pump's energy efficiency, the location of its installation and the current STC trading value. For more information on STCs, visit: ret.cleanenergyregulator.gov.au

Victorian Energy Efficiency Certificates

If you live in Victoria, there is an additional State Government program whereby eligible installations are awarded Victorian Energy Efficiency Certificates (VEECs), also redeemable for a cash rebate. If you qualify - you could be eligible for both the Federal and State Government rebates. For more information on VEECs, visit: www.veet.vic.gov.au

CALCULATE YOUR STC REBATE

Small Scale Technology Rebates

Visit quantumenergy.com.au and use our online STC calculator to find out how much you'll save by installing a Quantum Heat Pump.

Rebate application forms and information on how to make a claim are also available from our website.



STC Values for Quantum Products

Model	Description	Zone 1	Zone 2	Zone 3	Zone 4	Zone 5
150-08AC6-290	150L Solar Heat Pump	24	24	29	31	30
200-08AC6-290	200L Solar Heat Pump	24	23	28	30	29
270-08AC6-290	270L Solar Heat Pump	26	26	31	33	32
340-08AC6-290	340L Solar Heat Pump	25	25	30	33	32
270-08AS6-290	Platinum 270L Solar Heat Pump	26	26	31	33	32
340-17ACW-134	Titan Compact 340L Heat Pump	23	21	26	28	28
340-17ASW-134	Titan 340L Split System	23	22	27	28	28

A woman with a white towel on her head is shown in profile, cupping water in her hands over a sink faucet. The background is a blurred bathroom setting. The text is overlaid on the top right of the image.

DOMESTIC

Solar Heat Pumps

An extensive range of heat pumps for residential use.

DOMESTIC Features

- ✓ Compact design with integrated refrigeration unit
- ✓ Energy efficient hot water production that reduces energy use and greenhouse gas emissions†
- ✓ Easy installation
- ✓ Rebates available
- ✓ Designed and manufactured to Australian Standards
- ✓ Warranty
5 years tank, 2 years electric and refrigeration inclusive of parts and labour

150L Solar Heat Pump Model: 150-08AC6-290



SMALL
150
LITRE

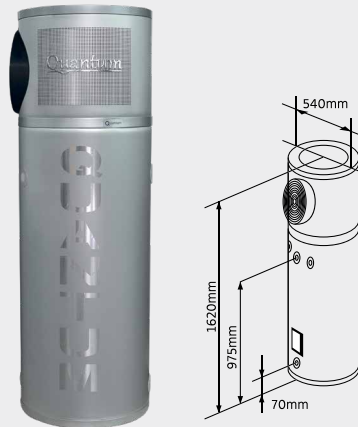

200L Solar Heat Pump Model: 200-08AC6-290



MEDIUM
200
LITRE

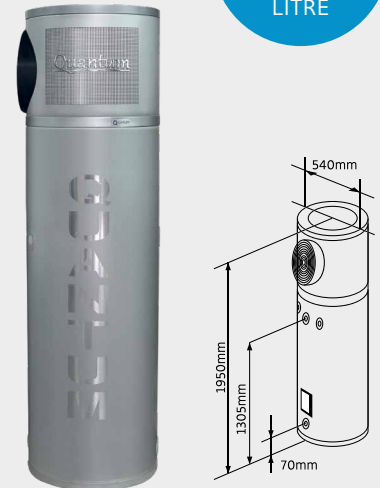

Storage Size	150 L	200 L
Rated Delivery	130 L	175 L
Heating Output	3.61 kW	3.61 kW
Power Input	0.84 kW	0.84 kW
COP of Heating*	4.3	4.3
Compressor	Rotary	Rotary
Refrigerant	R290	R290
Electrical Supply	220-240V/50Hz/1Ph	220-240V/50Hz/1Ph
Circuit	10 Amps	10 Amps
Water Connections	3/4" BSP	3/4" BSP
PTR Valve Setting	850 kPa	850 kPa
ECV Setting	700 kPa	700 kPa
PLV Without ECV Fitted	500 kPa	500 kPa
PLV With ECV Fitted	300-500 kPa	300-500 kPa
Operating Sound Level**	50 dBA	50 dBA
Dimensions (Height x Diameter)	1620 mm x 540 mm	1950 mm x 540 mm
Nett (Empty) Weight	115 kg	115 kg
Ambient Operating Temperature	-10 °C to +35 °C	-10 °C to +35 °C
Water Temperature Setting	60 °C	60 °C
Hot Water Production Rate*	72 L/hr	72 L/hr

*At an ambient temperature of 20°C. **At a height of 1.5 m above ground level. †Compared to traditional electric hot water storage units – Heat pump efficiency will vary by installation location.

270L Solar Heat Pump
Model: 270-08AC6-290



REGULAR
270
LITRE

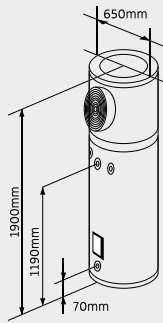

340L Solar Heat Pump
Model: 340-08AC6-290



LARGE
340
LITRE

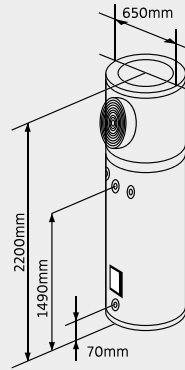

270 L

250 L

3.81 kW

0.84 kW

4.53

Rotary

R290

220-240V/50Hz/1Ph

10 Amps

3/4" BSP

850 kPa

700 kPa

500 kPa

300-500 kPa

48 dBA

1900 mm x 650 mm

135 kg

-10 °C to +35 °C

60 °C

75 L/hr

340 L

315 L

3.81 kW

0.84 kW

4.53

Rotary

R290

220-240V/50Hz/1Ph

10 Amps

3/4" BSP

850 kPa

700 kPa

500 kPa

300-500 kPa

48 dBA

2200 mm x 650 mm

170 kg

-10 °C to +35 °C

60 °C

75 L/hr

COMMERCIAL

Solar Heat Pumps

Ideal for resorts, hotels, office blocks and mining facilities.

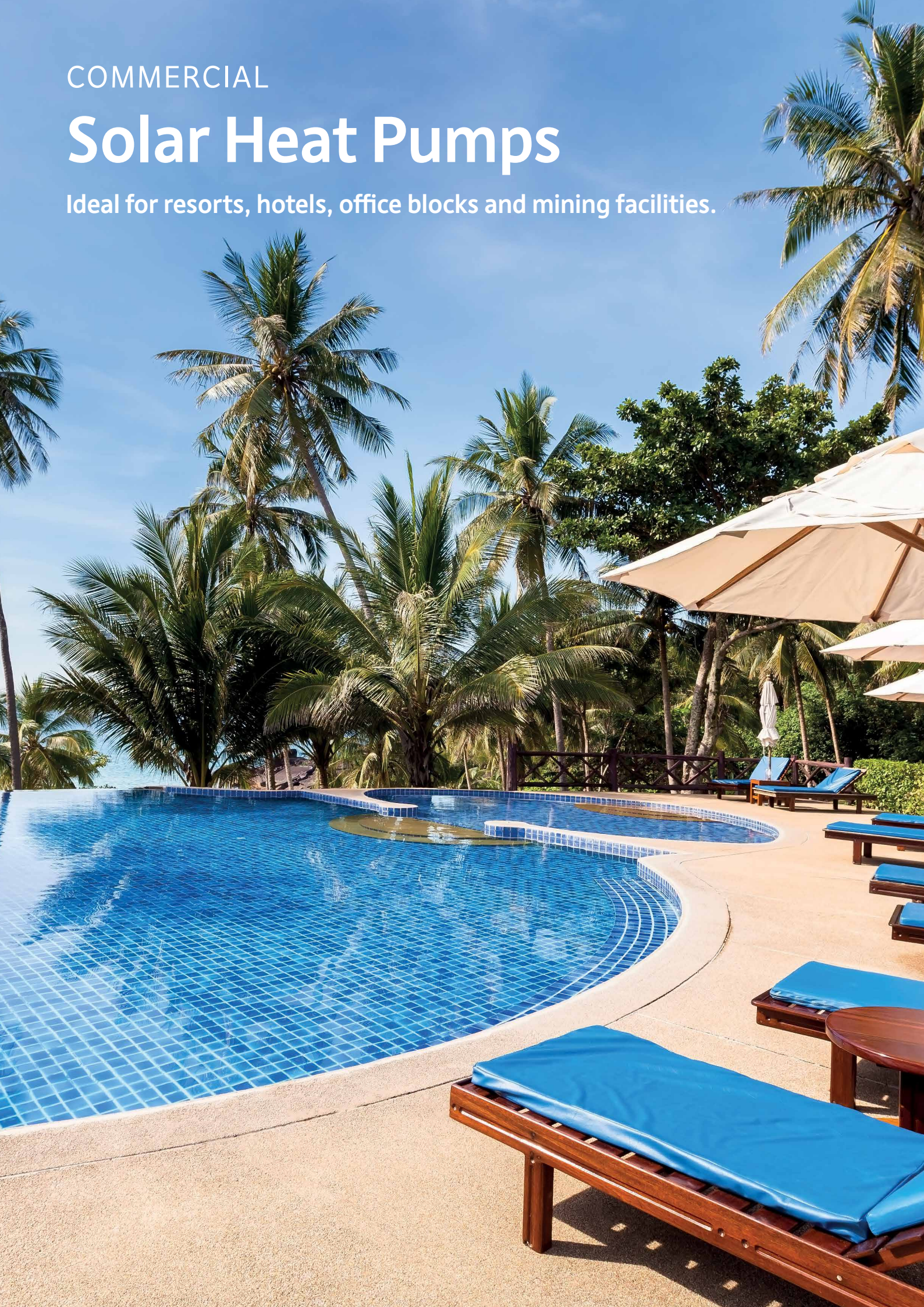

COMMERCIAL Features

- ✓ Compact design with integrated refrigeration unit or split system option
- ✓ Energy efficient hot water production that reduces energy use and greenhouse gas emissions†
- ✓ Easy installation
- ✓ Rebates available
- ✓ Designed and manufactured to Australian Standards
- ✓ Warranty
5 years tank, 2 years electric and refrigeration inclusive of parts and labour

Titan 340L Solar Heat Pump Model: 340-17ACW-134



8+



CAN BE
MANIFOLDED
TOGETHER



TITAN
340
LITRE

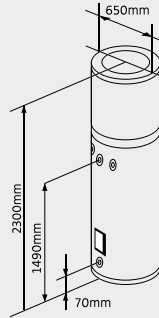

Titan 340L Split System Model: 340-17ASW-134



8+



CAN BE
MANIFOLDED
TOGETHER

TITAN SPLIT
340
LITRE

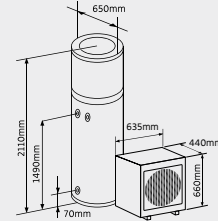

Evaporator may be remotely installed up to 8m from the tank.

Storage Size	340 L
Rated Delivery	315 L
Heating Output	6.22 kW
Power Input	1.66 kW
COP of Heating*	3.57
Compressor	39cc Rotary
Refrigerant	R134a
Electrical Supply	220-240V/50Hz/1Ph
Circuit	15 Amps
Water Connections	3/4" BSP
PTR Valve Setting	850 kPa
ECV Setting	700 kPa
PLV Without ECV Fitted	500 kPa
PLV With ECV Fitted	300-500 kPa
Operating Sound Level**	58 dBA
Dimensions (Height x Diameter)	2300 mm x 650 mm
Nett (Empty) Weight	180 kg
Ambient Operating Temperature	-10 °C to +35 °C
Water Temperature Setting	60 °C
Hot Water Production Rate*	134 L/hr

Storage Size	340 L
Rated Delivery	315 L
Heating Output	6.22 kW
Power Input	1.66 kW
COP of Heating*	3.57
Compressor	39cc Rotary
Refrigerant	R134a
Electrical Supply	220-240V/50Hz/1Ph
Circuit	15 Amps
Water Connections	3/4" BSP
PTR Valve Setting	850 kPa
ECV Setting	700 kPa
PLV Without ECV Fitted	500 kPa
PLV With ECV Fitted	300-500 kPa
Operating Sound Level**	58 dBA
Dimensions (Height x Diameter)	2300 mm x 650 mm
Nett (Empty) Weight	180 kg
Ambient Operating Temperature	-10 °C to +35 °C
Water Temperature Setting	60 °C
Hot Water Production Rate*	134 L/hr

Storage Size	340 L
Rated Delivery	315 L
Heating Output	6.22 kW
Power Input	1.66 kW
COP of Heating*	3.74
Compressor	39cc Rotary
Refrigerant	R134a
Electrical Supply	220-240V/50Hz/1Ph
Circuit	15 Amps
Water Connections	3/4" BSP
PTR Valve Setting	850 kPa
ECV Setting	700 kPa
PLV Without ECV Fitted	500 kPa
PLV With ECV Fitted	300-500 kPa
Operating Sound Level**	58 dBA
Dimensions (Height x Diameter)	2110 mm x 650 mm
Nett (Empty) Weight	165 kg + 35 kg
Ambient Operating Temperature	-10 °C to +35 °C
Water Temperature Setting	60 °C
Hot Water Production Rate*	134 L/hr

*At an ambient temperature of 20°C. **At a height of 1.5 m above ground level.

†Compared to traditional electric hot water storage units – Heat pump efficiency will vary by installation location.

How Does it Work?

A simple concept, brilliantly executed. The Quantum Solar Heat Pump works on a patented refrigeration principle similar to that found in an air conditioner, or refrigerator – but in reverse.

A traditional solar hot water service typically consists of collector panels or tubes fitted to your roof which water flows through and then into a storage tank. This service relies on the sun and in Australia can provide between 50-90% of hot water for your home³, an electric ‘booster element’ kicking in to cover any shortfall.

A Quantum Solar Heat Pump however makes use of the heat in the ambient air around the system, and a reverse refrigeration process to heat the water. This means the sun doesn’t need to be shining, and what’s more, it’s so efficient that it can provide reliable hot water 24 hours a day, even in temperatures as low as -10°C with no booster element.

Did you know?

A Quantum heat pump will cost just a fraction to run when compared to other traditional forms of water heating – representing a **significant financial benefit** as well as reducing greenhouse gas emissions and the environmental footprint of your home.

HOW IT WORKS

Solar Energy From the Air

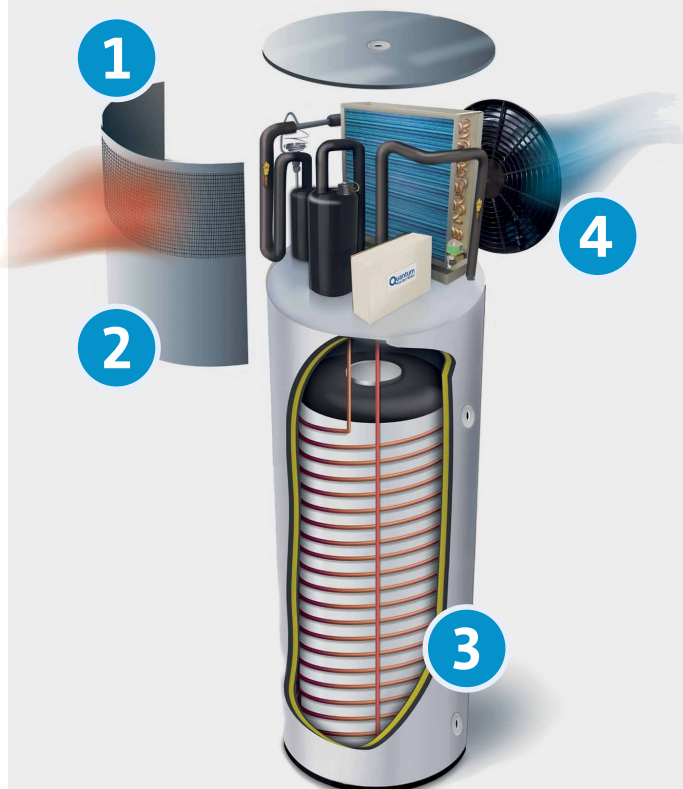

1 Sun heats the air

Heat pumps rely on ambient air temperature rather than incidental sunshine. Utilising refrigeration principles, Quantum Heat Pumps can extract heat from the air without the need for direct sunlight, and can produce hot water in rain, hail or shine – without the need for a booster element.

2 Energised air inducted into heat pump

Once the air is drawn into the heat pump, it passes over an evaporator containing a refrigerant which boils at a very low temperature. The boiling refrigerant is then compressed causing its’ temperature to be raised even further – transforming it into a super-heated vapour.

3 Energy transferred to heat cold water

Using Quantum’s patented Tank Wrap™ technology, this super-heated vapour is fed through copper coils (condenser) wrapped around the outside of the water tank, heating the water evenly and efficiently from the outside in.

4 Cold air expelled

Once the heat has been extracted from the air and transferred to the water, the remaining cold air is discharged from the heat pump by fan. Once the desired water temperature is reached, the system will go into energy-saving standby mode until it is required to commence heating again.

³ <http://www.energyrating.gov.au>



PRODUCT SPECIFICATIONS

Hot Water Efficiency

Hot Water Production Rate (COP)

Ambient Air Temperature	Hot Water Production Rate, Litres per Hour (COP)						
	150L	200L	270L	340L	Platinum 270L	340L	340L Split
	150-08AC6-290	200-08AC6-290	270-08AC6-290	340-08AC6-290	270-08AS6-290	340-17ACW-134	340-17ASW-134
35 °C	110 L/hr (5.55)	110 L/hr (5.55)	113 L/hr (5.75)	113 L/hr (5.75)	113 L/hr (5.75)	199 L/hr (5.30)	199 L/hr (5.30)
30 °C	98 L/hr (5.12)	98 L/hr (5.12)	102 L/hr (5.42)	102 L/hr (5.42)	102 L/hr (5.42)	177 L/hr (4.69)	177 L/hr (4.69)
25 °C	85 L/hr (4.73)	85 L/hr (4.73)	89 L/hr (4.98)	89 L/hr (4.98)	89 L/hr (4.98)	154 L/hr (4.09)	154 L/hr (4.09)
20 °C	72 L/hr (4.30)	72 L/hr (4.30)	75 L/hr (4.53)	75 L/hr (4.53)	75 L/hr (4.53)	131 L/hr (3.57)	131 L/hr (3.57)
15 °C	58 L/hr (3.88)	58 L/hr (3.88)	61 L/hr (4.08)	61 L/hr (4.08)	61 L/hr (4.08)	109 L/hr (3.03)	109 L/hr (3.03)
10 °C	48 L/hr (3.45)	48 L/hr (3.45)	51 L/hr (3.64)	51 L/hr (3.64)	51 L/hr (3.64)	90 L/hr (2.53)	90 L/hr (2.53)
5 °C	38 L/hr (3.03)	38 L/hr (3.03)	42 L/hr (3.19)	42 L/hr (3.19)	42 L/hr (3.19)	73 L/hr (2.09)	73 L/hr (2.09)
0 °C	31 L/hr (2.60)	31 L/hr (2.60)	33 L/hr (2.75)	33 L/hr (2.75)	33 L/hr (2.75)	59 L/hr (1.71)	59 L/hr (1.71)
-5 °C	26 L/hr (2.18)	26 L/hr (2.18)	29 L/hr (2.30)	29 L/hr (2.30)	29 L/hr (2.30)	51 L/hr (1.50)	51 L/hr (1.50)
-10 °C	24 L/hr (1.75)	24 L/hr (1.75)	26 L/hr (1.86)	26 L/hr (1.86)	26 L/hr (1.86)	45 L/hr (1.34)	45 L/hr (1.34)



Quantum

**Make your next water heater
a Quantum heat pump.**

quantumenergy.com.au

Sales Enquiries ☎ **1800 644 705**
Email: sales@quantumenergy.com.au

Warranty & Service ☎ **1800 644 705**
Email: service@quantumenergy.com.au

Quantum Energy Technologies Pty Ltd
22 Rosebery Avenue
Rosebery NSW 2018

Warranty

Our goods come with guarantees that cannot be excluded under the Australian Consumer Law. You are entitled to a replacement or refund for a major failure and for compensation for any other reasonably foreseeable loss or damage. You are also entitled to have the goods repaired or replaced if the goods fail to be of acceptable quality and the failure does not amount to a major failure. Refer to quantumenergy.com.au for warranty details.

WARNING: Products in this brochure and all literature pertaining to, are subject to Intellectual Property Protection. All dimensions given are approximate and should be checked prior to installation.



AS2712 LIC.2650
SAI GLOBAL



AS3498 WMKA2531
SAI GLOBAL